

A Discussion Game for Grounded Semantics

Martin Caminada

*Cardiff University
School of Computer Science*

Formal Preliminaries (1/2)

$AF = (Ar, att)$

Lab: $Ar \rightarrow \{\text{in, out, undec}\}$

Formal Preliminaries (1/2)

$AF = (Ar, att)$

$Lab: Ar \rightarrow \{in, out, undec\}$

Admissible Labelling:

- if **in** then all attackers **out**
- if **out** then there is an attacker **in**

Formal Preliminaries (1/2)

$AF = (Ar, att)$

$Lab: Ar \rightarrow \{in, out, undec\}$

Admissible Labelling:

- if **in** then all attackers **out**
- if **out** then there is an attacker **in**

Complete Labelling: admissible labelling that also satisfies

- if **undec** then not all attackers **out** and no attacker **in**

Formal Preliminaries (1/2)

$AF = (Ar, att)$

$Lab: Ar \rightarrow \{in, out, undec\}$

Admissible Labelling:

- if **in** then all attackers **out**
- if **out** then there is an attacker **in**

Complete Labelling: admissible labelling that also satisfies

- if **undec** then not all attackers **out** and no attacker **in**

$Lab_1 \sqsubseteq Lab_2 \stackrel{\text{def}}{=} in(Lab_1) \subseteq in(Lab_2) \wedge out(Lab_1) \subseteq out(Lab_2)$

Formal Preliminaries (1/2)

AF = (Ar, att)

Lab: Ar \rightarrow {in, out, undec}

Admissible Labelling:

- if in then all attackers out
- if out then there is an attacker in

Complete Labelling: admissible labelling that also satisfies

- if undec then not all attackers out and no attacker in

$\text{Lab}_1 \sqsubseteq \text{Lab}_2 \stackrel{\text{def}}{=} \text{in}(\text{Lab}_1) \subseteq \text{in}(\text{Lab}_2) \wedge \text{out}(\text{Lab}_1) \subseteq \text{out}(\text{Lab}_2)$

*Complete labellings form a semi-lattice (w.r.t. \sqsubseteq)
with grounded at the bottom and preferreds at the top*

Example

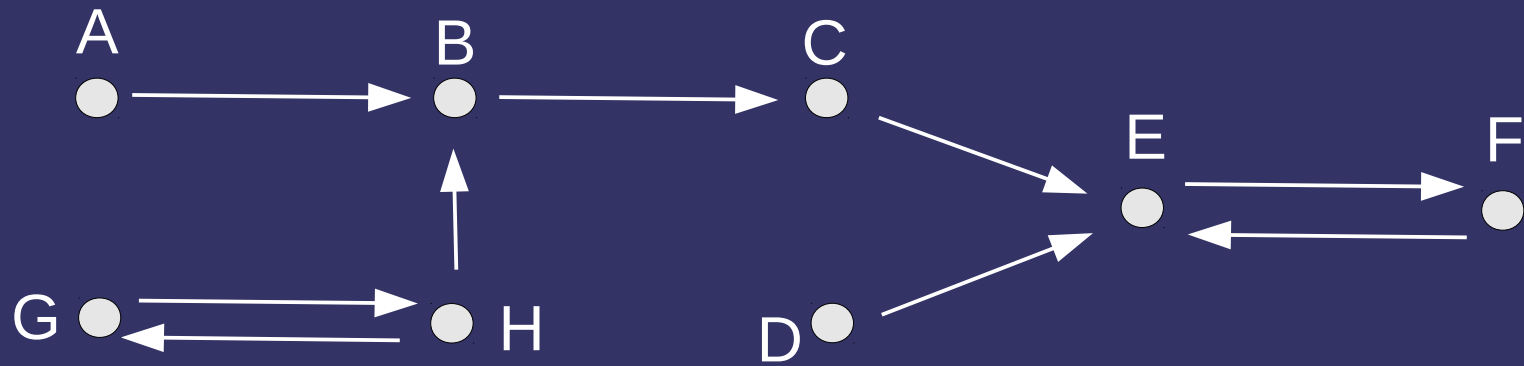

Example

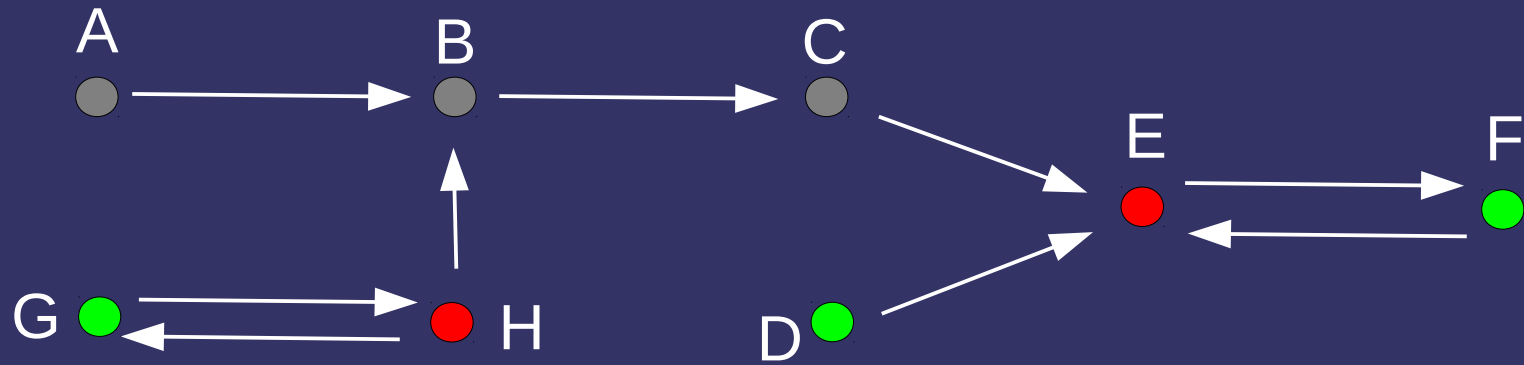

Example

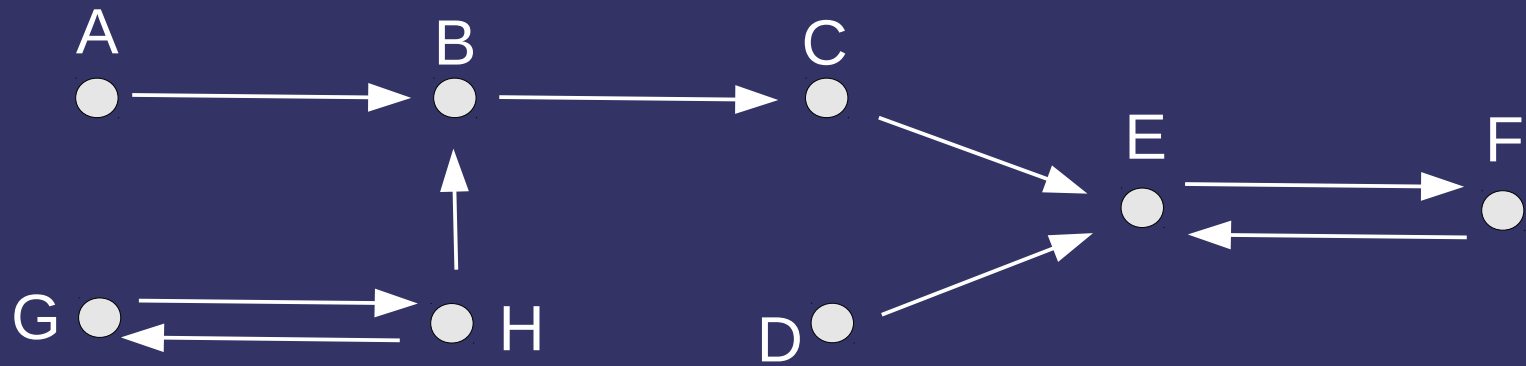

Example

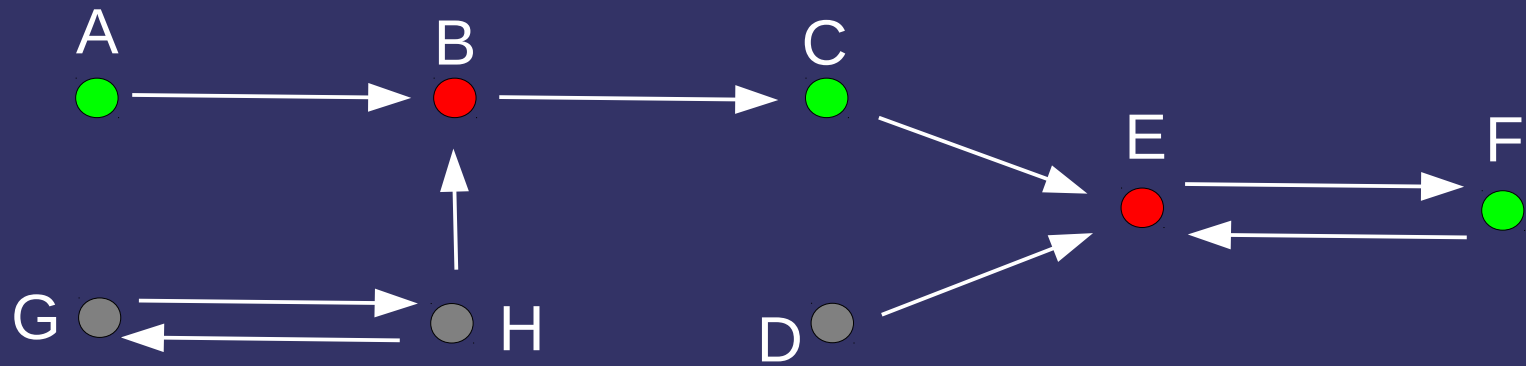

Example

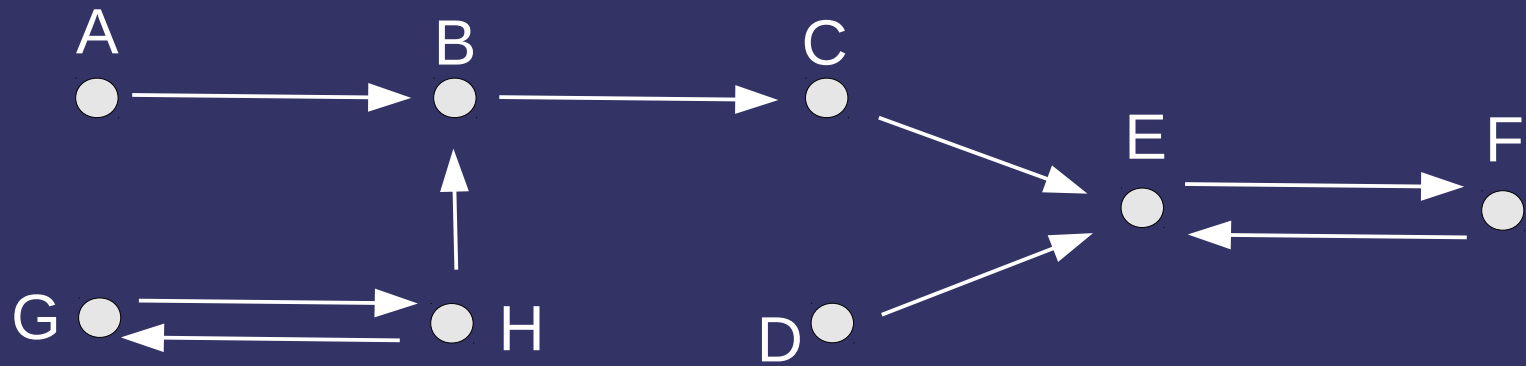

Example

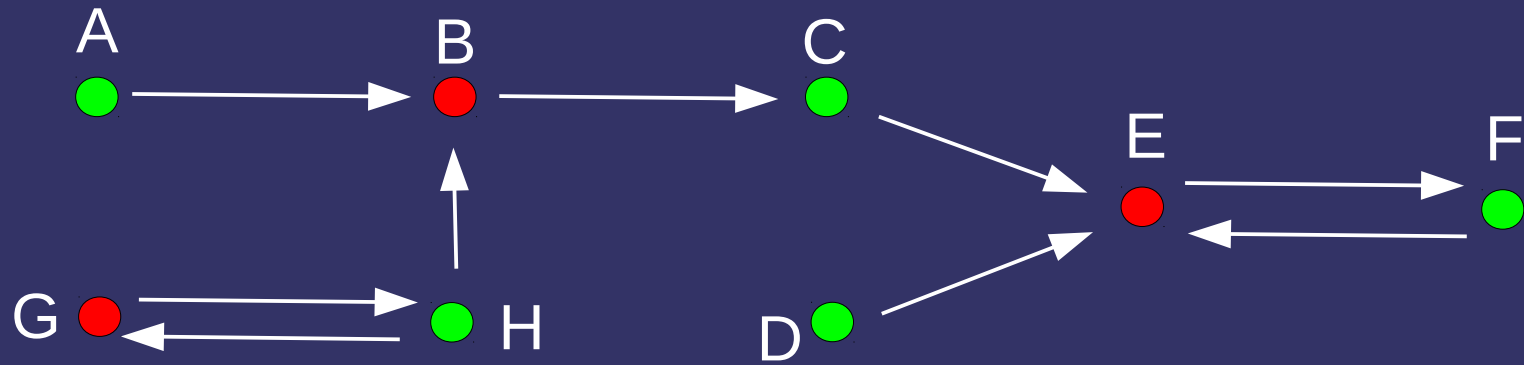

Example

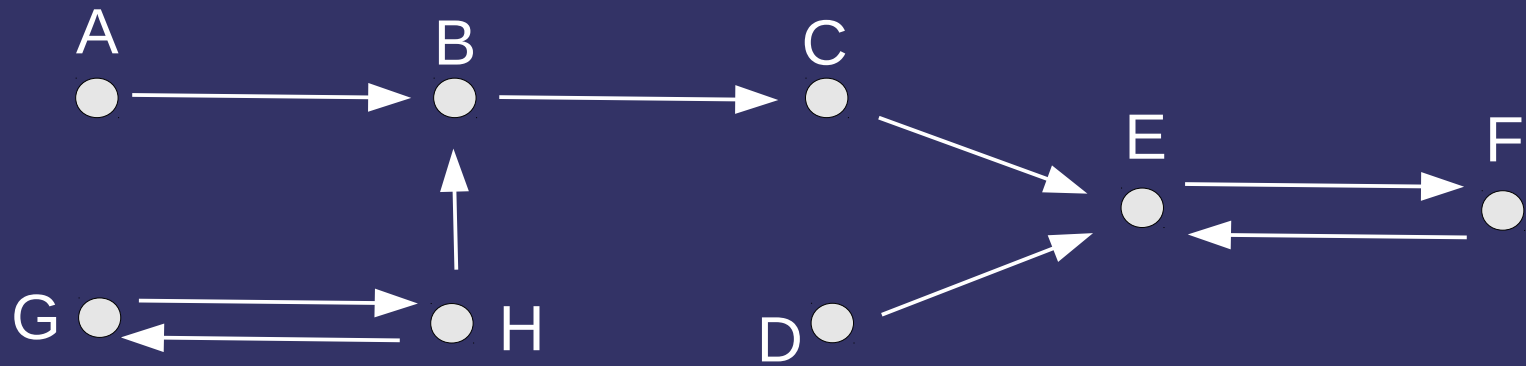

Example

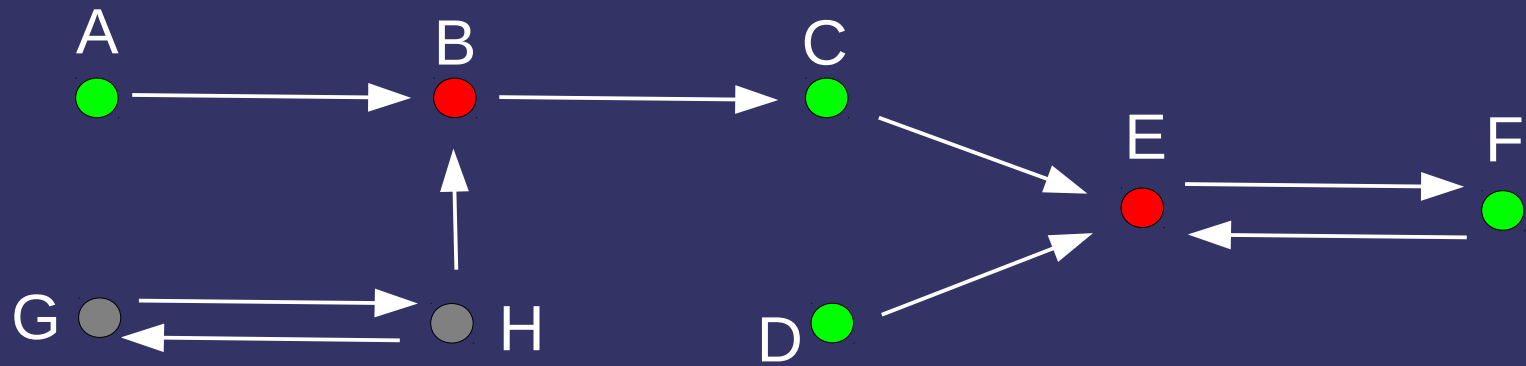

Formal Preliminaries (2/2)

Formal Preliminaries (2/2)

MinMax numbering $MM: \text{in}(\text{Lab}) \cup \text{out}(\text{Lab}) \rightarrow \mathbb{N} \cup \{\infty\}$

Formal Preliminaries (2/2)

MinMax numbering $MM: \text{in}(\text{Lab}) \cup \text{out}(\text{Lab}) \rightarrow \mathbb{N} \cup \{\infty\}$

- If A is **in** then $MM(A)$ is the $\text{MAX}+1$ value of its **out**-labelled attackers

Formal Preliminaries (2/2)

MinMax numbering $MM: \text{in}(\text{Lab}) \cup \text{out}(\text{Lab}) \rightarrow \mathbb{N} \cup \{\infty\}$

- If A is **in** then $MM(A)$ is the $\text{MAX}+1$ value of its **out**-labelled attackers
- If A is **out** then $MM(A)$ is the $\text{MIN}+1$ value of its **in**-labelled attackers

Formal Preliminaries (2/2)

MinMax numbering $MM: \text{in}(\text{Lab}) \cup \text{out}(\text{Lab}) \rightarrow \mathbb{N} \cup \{\infty\}$

- If A is **in** then $MM(A)$ is the $\text{MAX}+1$ value of its **out**-labelled attackers
- If A is **out** then $MM(A)$ is the $\text{MIN}+1$ value of its **in**-labelled attackers

Every admissible labelling has a unique MinMax numbering

Formal Preliminaries (2/2)

MinMax numbering $MM: \text{in}(\text{Lab}) \cup \text{out}(\text{Lab}) \rightarrow \mathbb{N} \cup \{\infty\}$

- If A is **in** then $MM(A)$ is the $\text{MAX}+1$ value of its **out**-labelled attackers
- If A is **out** then $MM(A)$ is the $\text{MIN}+1$ value of its **in**-labelled attackers

Every admissible labelling has a unique MinMax numbering

Strongly Admissible Labeling: admissible labelling whose MinMax numbering contains natural numbers only (no ∞)

Formal Preliminaries (2/2)

MinMax numbering $MM: \text{in}(\text{Lab}) \cup \text{out}(\text{Lab}) \rightarrow \mathbb{N} \cup \{\infty\}$

- If A is **in** then $MM(A)$ is the $\text{MAX}+1$ value of its **out**-labelled attackers
- If A is **out** then $MM(A)$ is the $\text{MIN}+1$ value of its **in**-labelled attackers

Every admissible labelling has a unique MinMax numbering

Strongly Admissible Labeling: admissible labelling whose MinMax numbering contains natural numbers only (no ∞)

The strongly admissible labellings form a lattice with the all-undec at the bottom and the grounded at the top

Formal Preliminaries (2/2)

MinMax numbering $MM: \text{in}(\text{Lab}) \cup \text{out}(\text{Lab}) \rightarrow \mathbb{N} \cup \{\infty\}$

- If A is **in** then $MM(A)$ is the $\text{MAX}+1$ value of its **out**-labelled attackers
- If A is **out** then $MM(A)$ is the $\text{MIN}+1$ value of its **in**-labelled attackers

Every admissible labelling has a unique MinMax numbering

Strongly Admissible Labeling: admissible labelling whose MinMax numbering contains natural numbers only (no ∞)

The strongly admissible labellings form a lattice with the all-undec at the bottom and the grounded at the top

A **in** in str. adm. \equiv A **in** in grounded (details:COMMA14)

Example

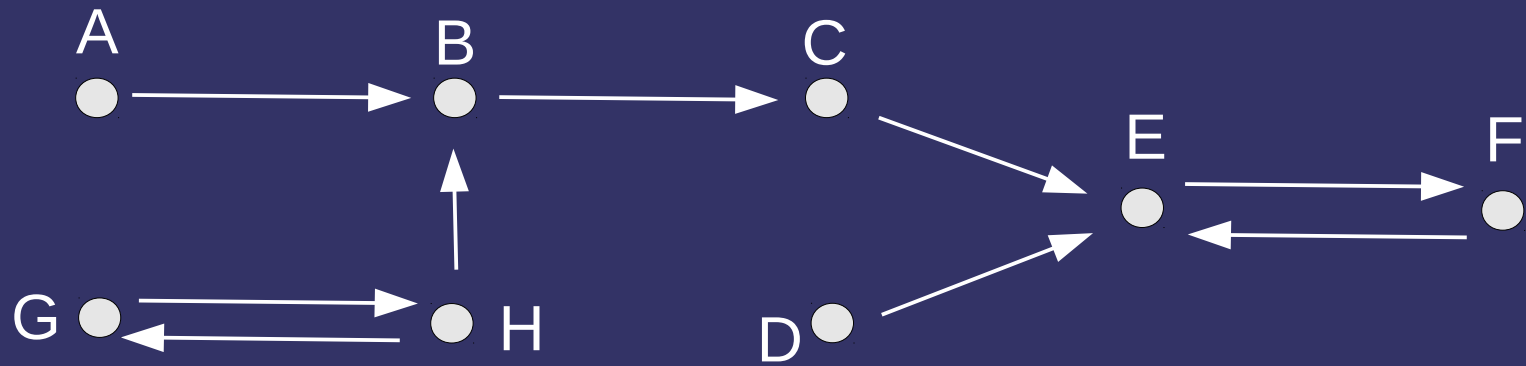

Example

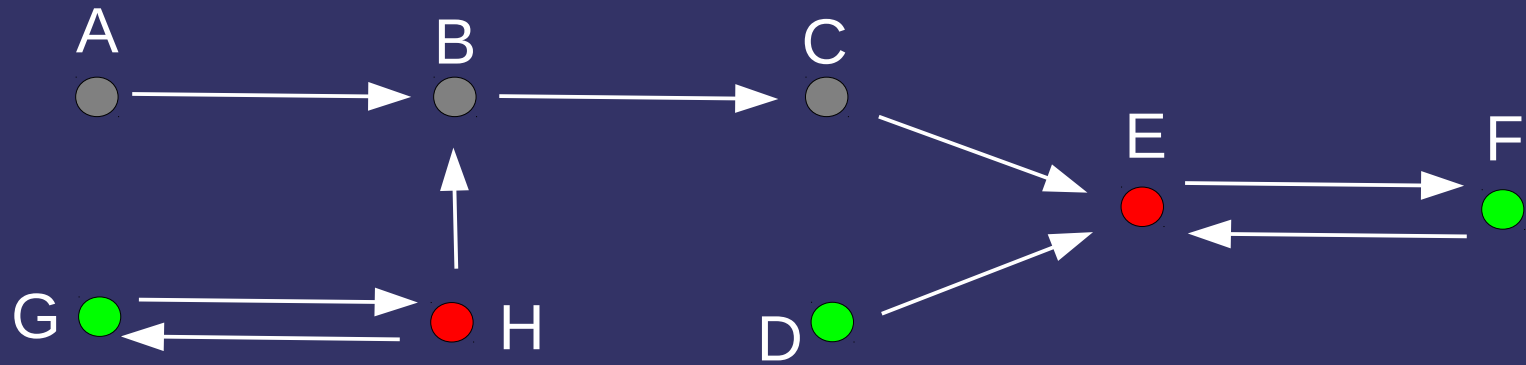

Example

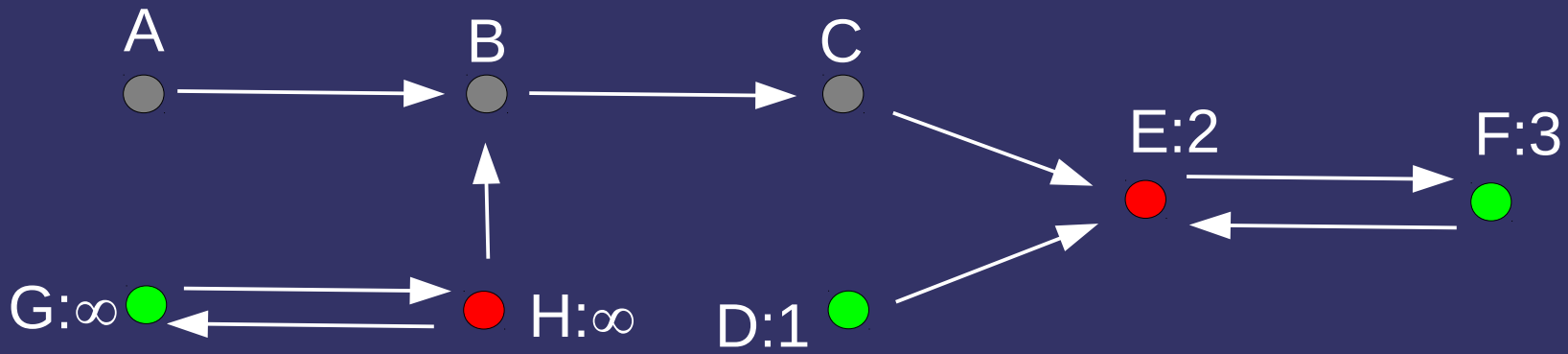

Example

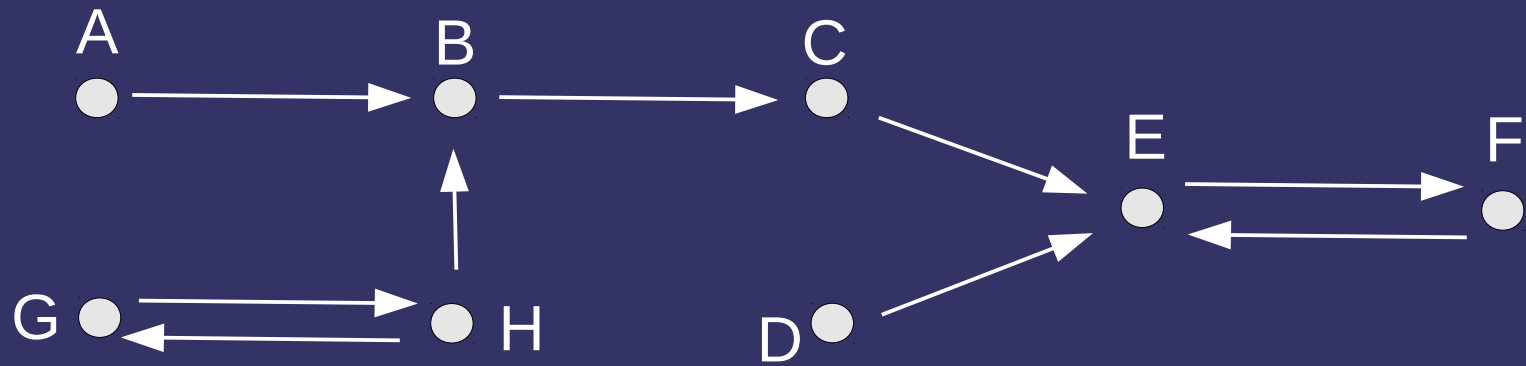

Example

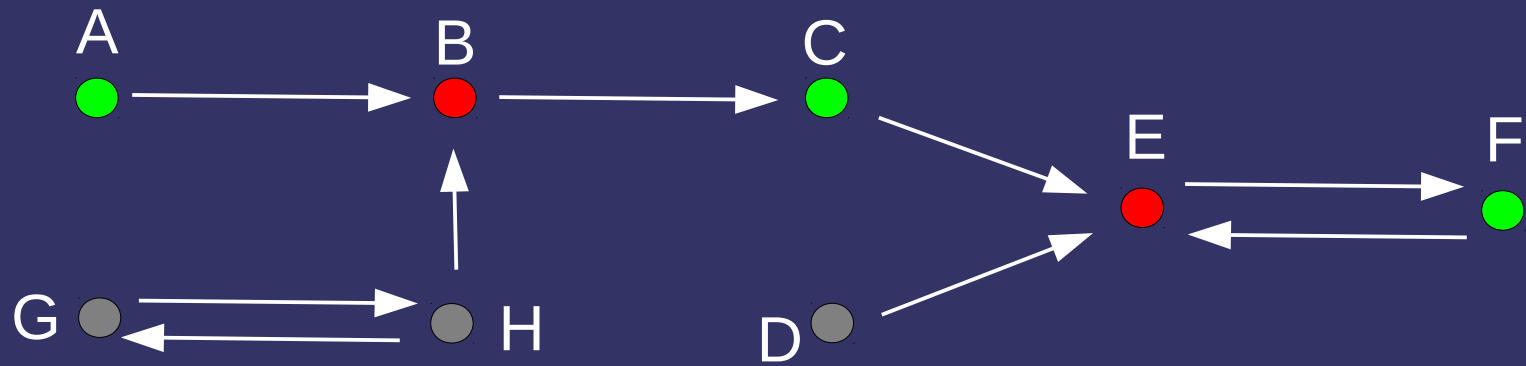

Example

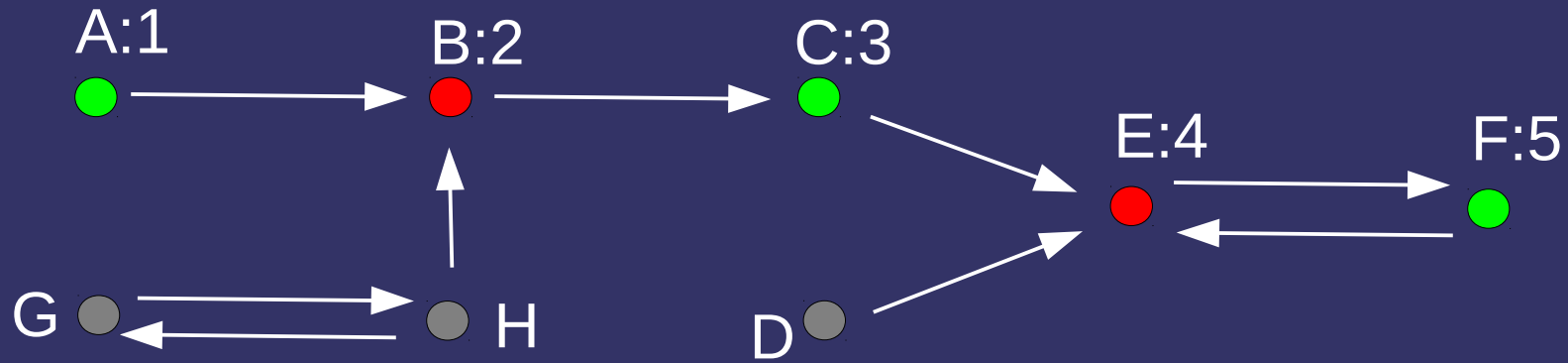

Example

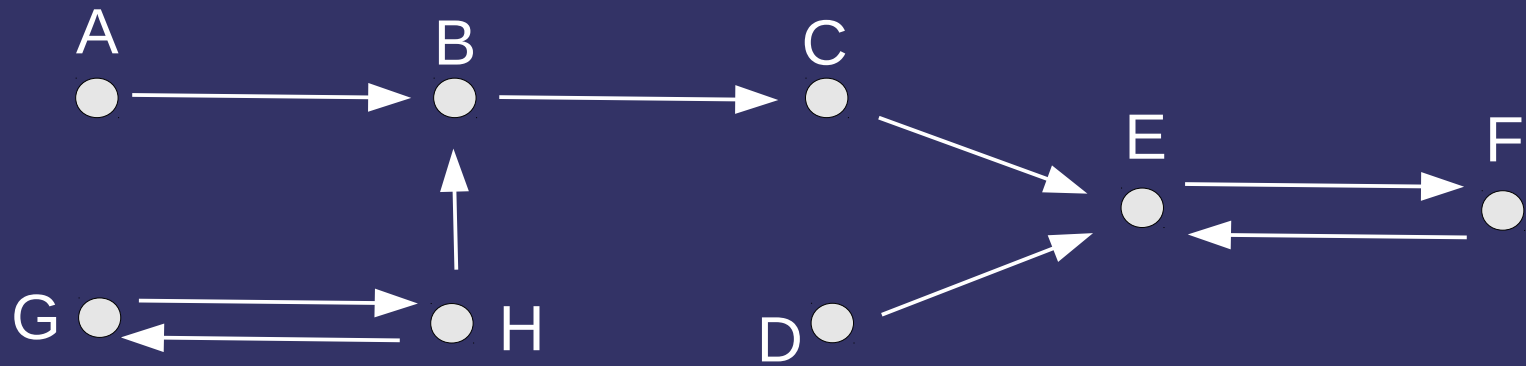

Example

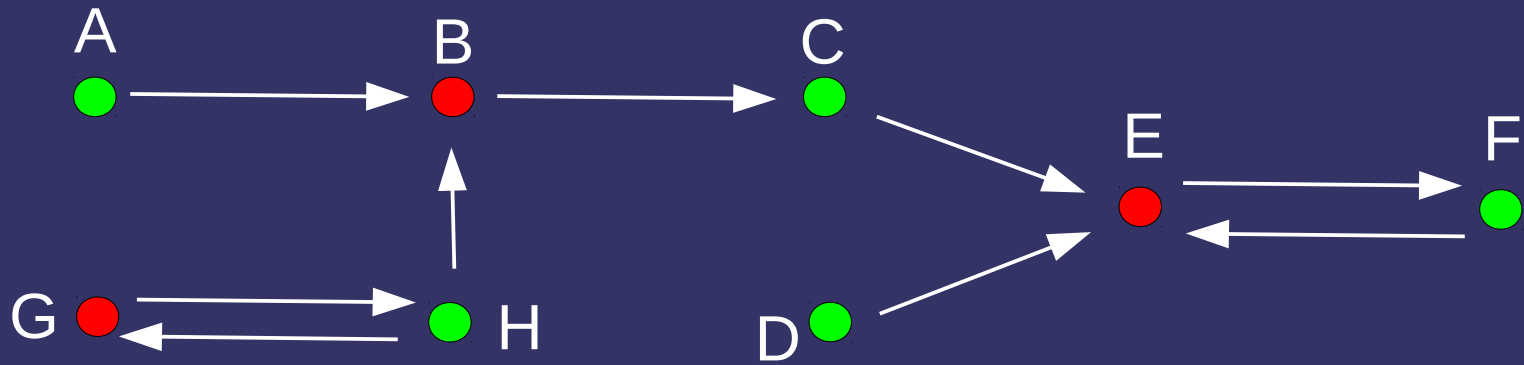

Example

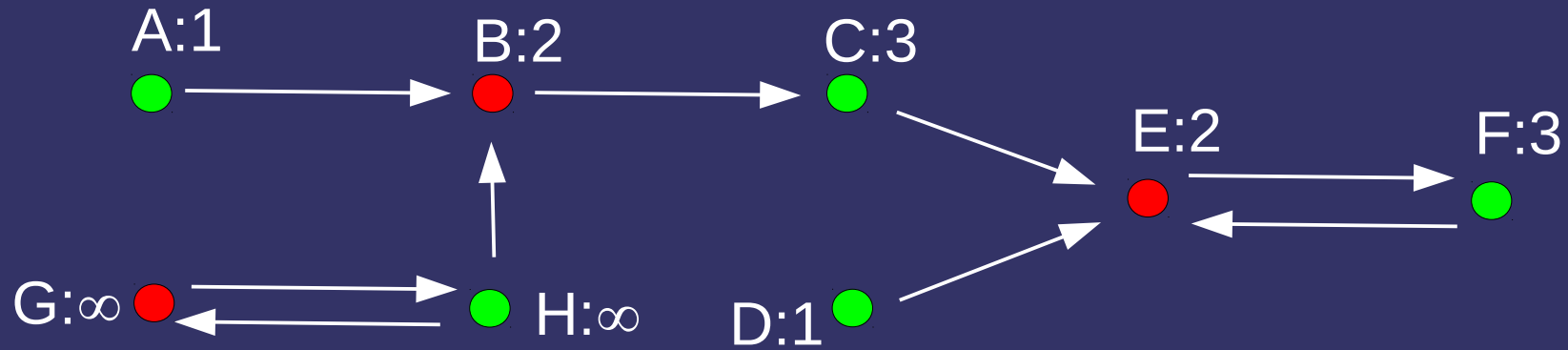

Example

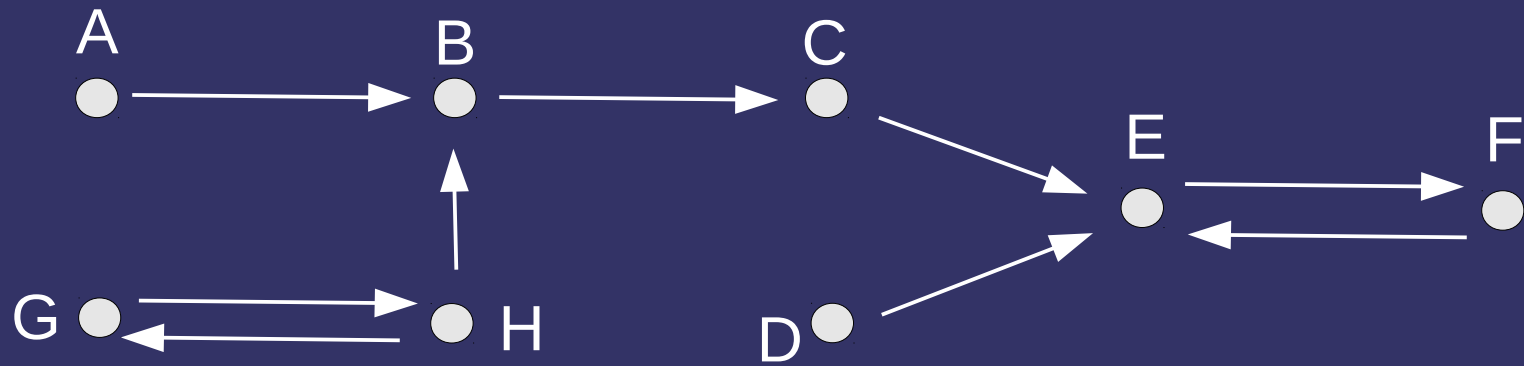

Example

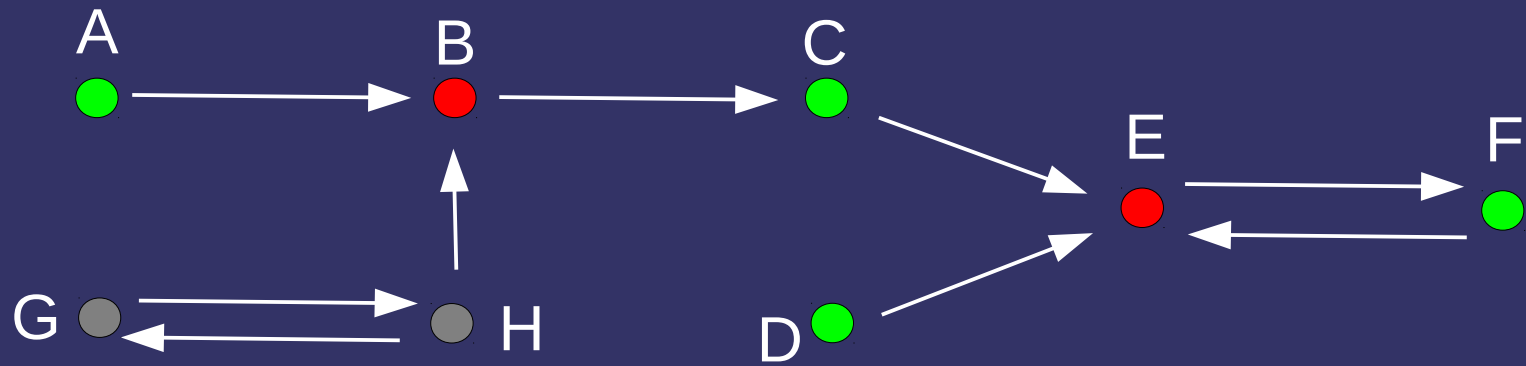

Example

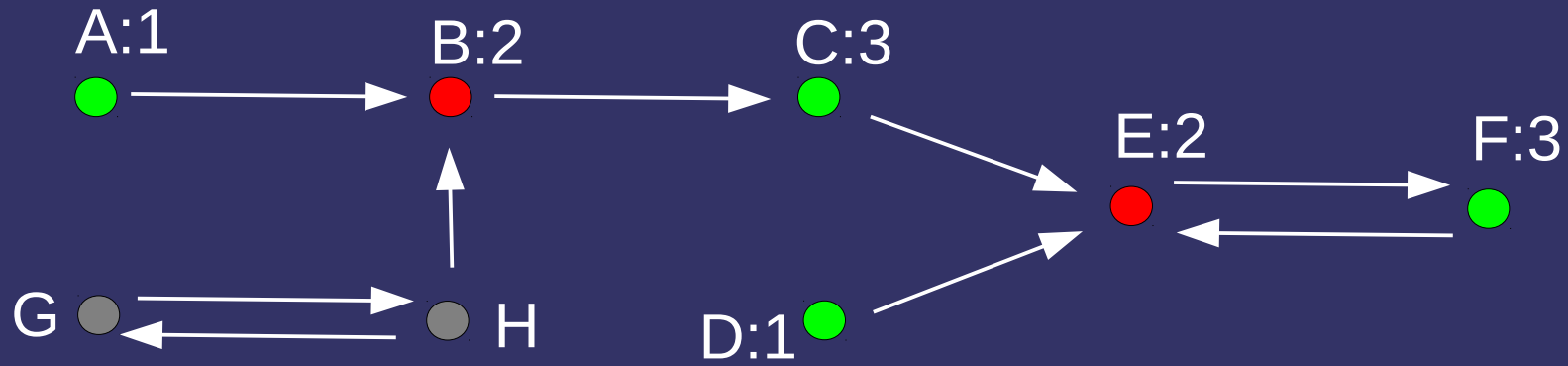

***A Discussion Game
for Grounded Semantics (1/3)***

A Discussion Game for Grounded Semantics (1/3)

two players:

- proponent (P)
- opponent (O)

A Discussion Game for Grounded Semantics (1/3)

two players:

- proponent (P)
- opponent (O)

four moves ($A, B \in Ar$)

- (1) P: HTB(A)
“A has to be the case”
- (2) O: CB(B)
“B can be the case”
- (3) O: CONCEDE(A)
“I now agree that A”
- (4) O: RETRACT(B)
“I no longer hold that B can be the case”

A Discussion Game for Grounded Semantics (1/3)

two players:

- proponent (P)
- opponent (O)

four moves ($A, B \in Ar$)

- (1) P: HTB(A)
“A is labelled **in** by every complete”
- (2) O: CB(B)
“B can be the case”
- (3) O: CONCEDE(A)
“I now agree that A”
- (4) O: RETRACT(B)
“I no longer hold that B can be the case”

A Discussion Game for Grounded Semantics (1/3)

two players:

- proponent (P)
- opponent (O)

four moves ($A, B \in Ar$)

(1) P: HTB(A)

“A is labelled **in** by every complete”

(2) O: CB(B)

“Perhaps B isn't labelled **out** by every complete”

(3) O: CONCEDE(A)

“I now agree that A”

(4) O: RETRACT(B)

“I no longer hold that B can be the case”

A Discussion Game for Grounded Semantics (1/3)

two players:

- proponent (P)
- opponent (O)

four moves ($A, B \in Ar$)

(1) P: HTB(A)

“A is labelled **in** by every complete”

(2) O: CB(B)

“Perhaps B isn't labelled **out** by every complete”

(3) O: CONCEDE(A)

“I now agree that A is labelled **in** by every complete”

(4) O: RETRACT(B)

“I no longer hold that B can be the case”

A Discussion Game for Grounded Semantics (1/3)

two players:

- proponent (P)
- opponent (O)

four moves ($A, B \in Ar$)

(1) P: HTB(A)

“A is labelled **in** by every complete”

(2) O: CB(B)

“Perhaps B isn't labelled **out** by every complete”

(3) O: CONCEDE(A)

“I now agree that A is labelled **in** by every complete”

(4) O: RETRACT(B)

“I no longer hold that B isn't labelled **out** by every complete”

A Discussion Game for Grounded Semantics (1/3)

two players:

- proponent (P)
- opponent (O)

four moves ($A, B \in Ar$)

(1) P: HTB(A)

“A is labelled **in** by every complete”

(2) O: CB(B)

“Perhaps B isn't labelled **out** by every complete”

(3) O: CONCEDE(A)

“I now agree that A is labelled **in** by every complete”

(4) O: RETRACT(B)

“I now think that B is labelled **out** by every complete”

Example

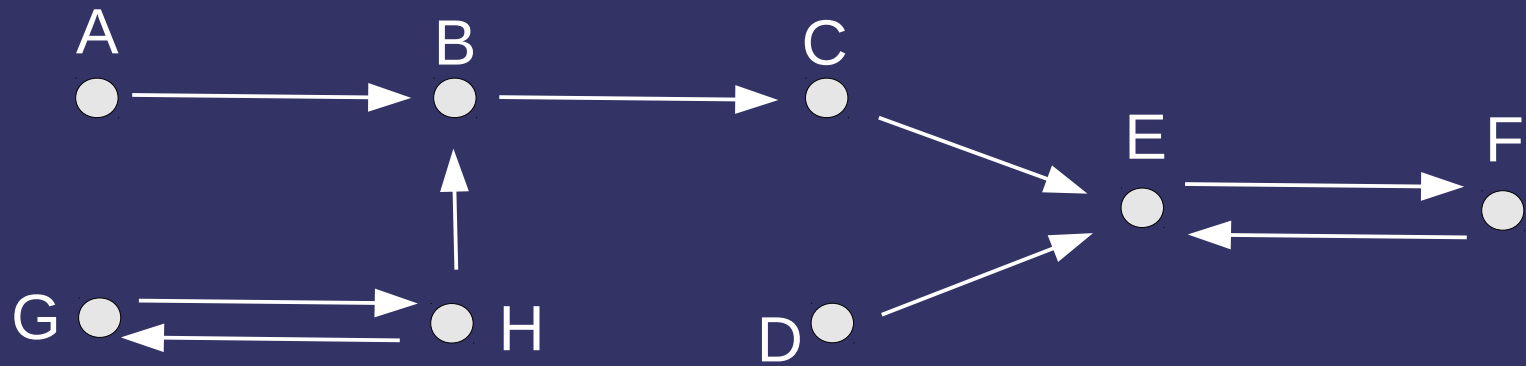

Example

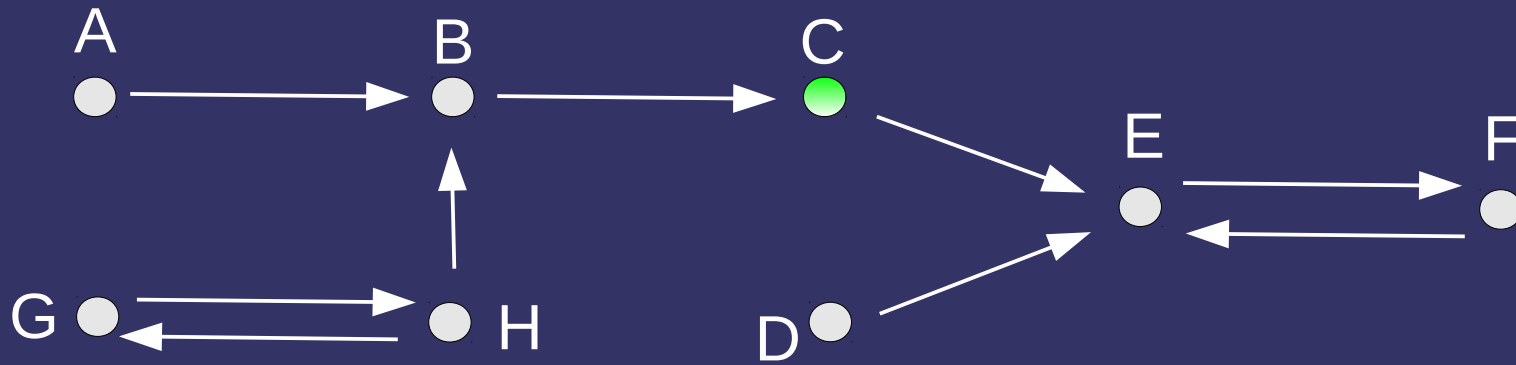

P: HTB(C)

Example

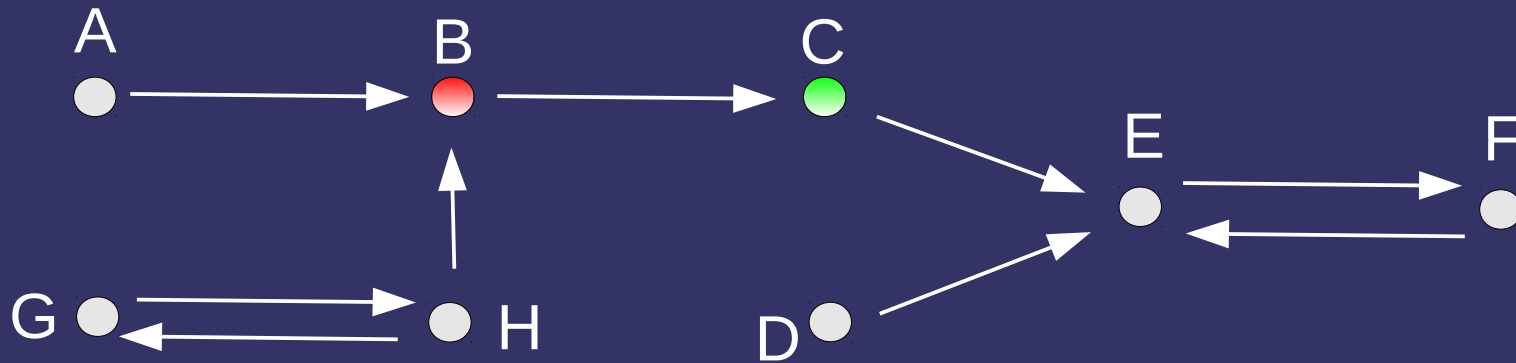

P: HTB(C)

O: CB(B)

Example

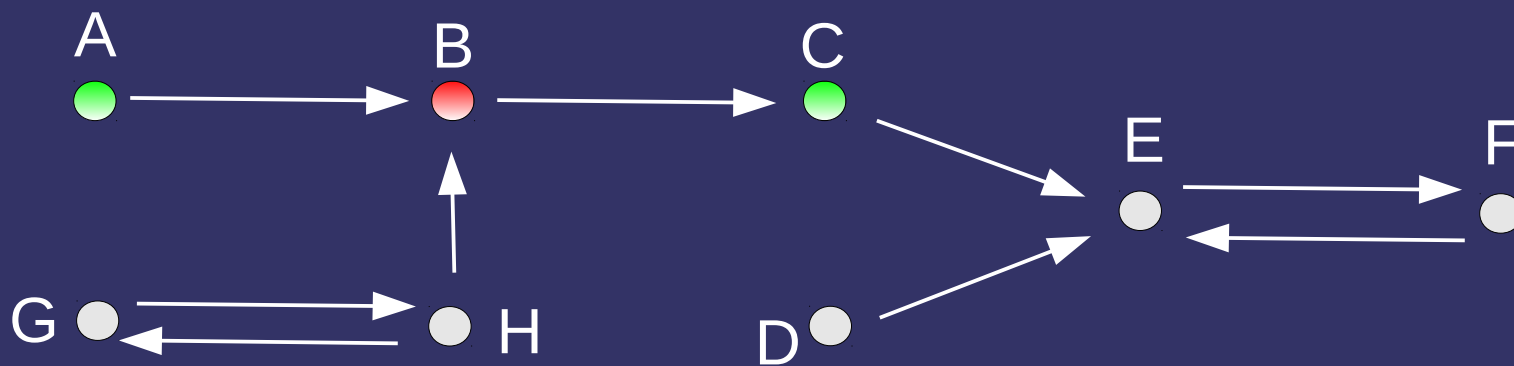

P: HTB(C)

O: CB(B)

P: HTB(A)

Example

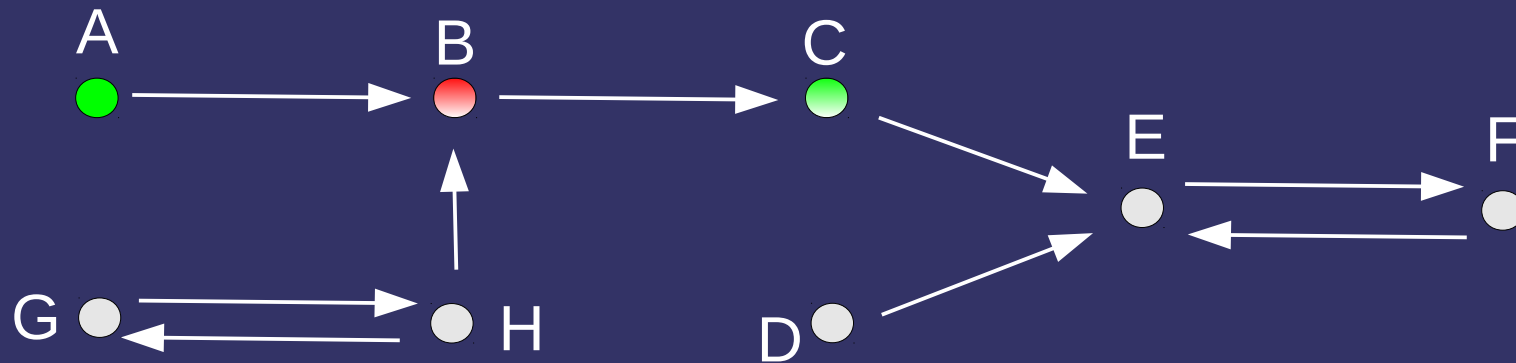

P: HTB(C)

O: CB(B)

P: HTB(A)

O: CONCEDE(A)

Example

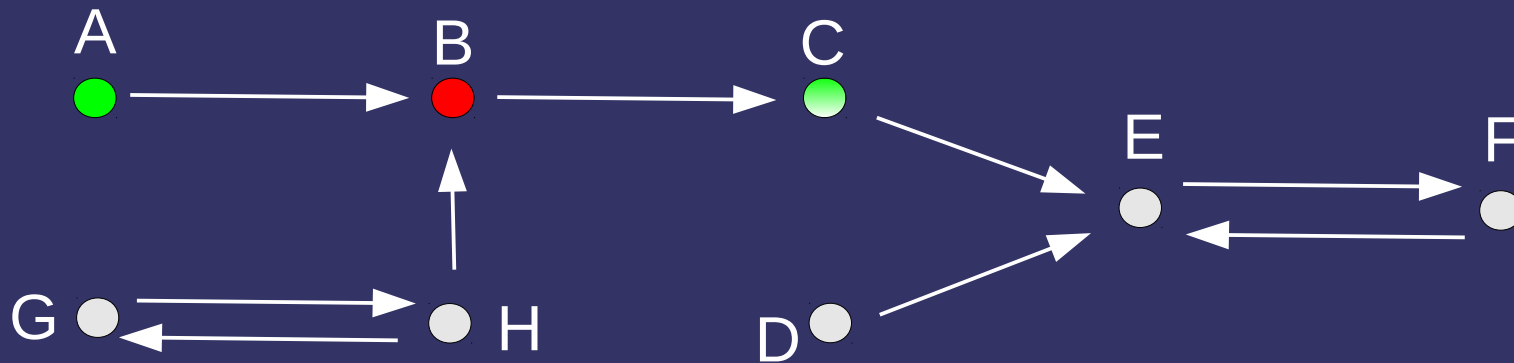

P: HTB(C)

O: CB(B)

P: HTB(A)

O: CONCEDE(A)

O: RETRACT(B)

Example

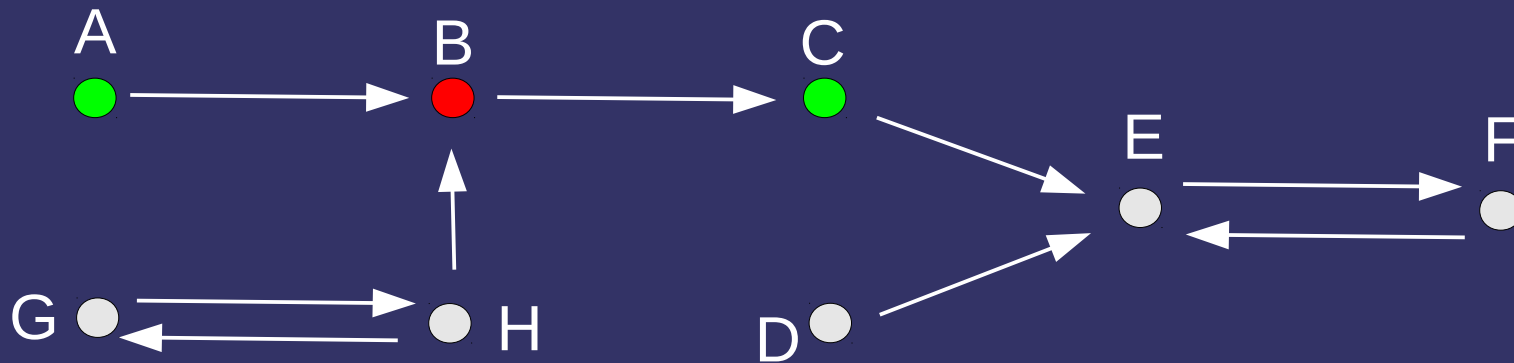

P: HTB(C)

O: CB(B)

P: HTB(A)

O: CONCEDE(A)

O: RETRACT(B)

O: CONCEDE(C)

***A Discussion Game
for Grounded Semantics (2/3)***

A Discussion Game for Grounded Semantics (2/3)

- HTB(A) This is either the first move, or
- preceding move was CB(B) and A attacks B
 - no CONCEDE or RETRACT move is applicable

A Discussion Game for Grounded Semantics (2/3)

HTB(A) This is either the first move, or

- preceding move was CB(B) and A attacks B
- no CONCEDE or RETRACT move is applicable

CB(B)

- B attacks the last HTB(A) statement that is not yet CONCEDEd
- preceding move was not a CB statement
- B has not yet been RETRACTed
- no CONCEDE or RETRACT move is applicable

A Discussion Game for Grounded Semantics (2/3)

HTB(A) This is either the first move, or

- preceding move was CB(B) and A attacks B
- no CONCEDE or RETRACT move is applicable

CB(B)

- B attacks the last HTB(A) statement that is not yet CONCEDEd
- preceding move was not a CB statement
- B has not yet been RETRACTed
- no CONCEDE or RETRACT move is applicable

CONCEDE(A)

- there has been a HTB(A) statement in the past...
- ...of which every attacker has been RETRACTed
- and CONCEDE(A) hasn't yet been moved

A Discussion Game for Grounded Semantics (2/3)

HTB(A) This is either the first move, or

- preceding move was CB(B) and A attacks B
- no CONCEDE or RETRACT move is applicable

CB(B)

- B attacks the last HTB(A) statement that is not yet CONCEDEd
- preceding move was not a CB statement
- B has not yet been RETRACTed
- no CONCEDE or RETRACT move is applicable

CONCEDE(A)

- there has been a HTB(A) statement in the past...
- ...of which every attacker has been RETRACTed
- and CONCEDE(A) hasn't yet been moved

RETRACT(B)

- there has been a CB(B) statement in the past...
- ...of which an attacker has been CONCEDEd
- and RETRACT(B) hasn't yet been moved

A Discussion Game for Grounded Semantics (2/3)

HTB(A) This is either the first move, or

- preceding move was CB(B) and A attacks B
- no CONCEDE or RETRACT move is applicable

CB(B)

- B attacks the last HTB(A) statement that is not yet CONCEDEd
- preceding move was not a CB statement
- B has not yet been RETRACTed
- no CONCEDE or RETRACT move is applicable

CONCEDE(A)

- there has been a HTB(A) statement in the past...
- ...of which every attacker has been RETRACTed
- and CONCEDE(A) hasn't yet been moved

RETRACT(B)

- there has been a CB(B) statement in the past...
- ...of which an attacker has been CONCEDEd
- and RETRACT(B) hasn't yet been moved

additional
condition
for all moves
no HTB-CB
repeats have
occurred

Example

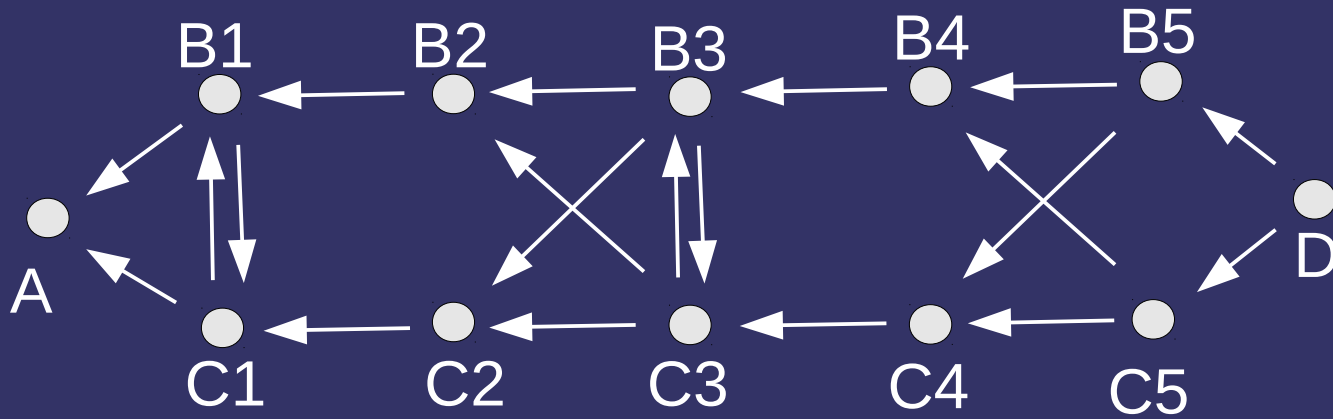

Example

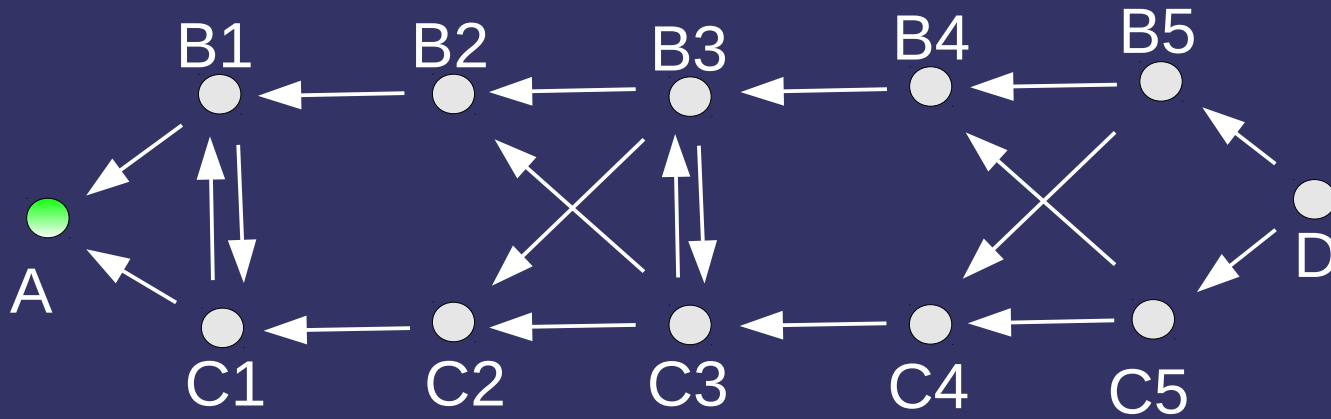

P: HTB(A)

Example

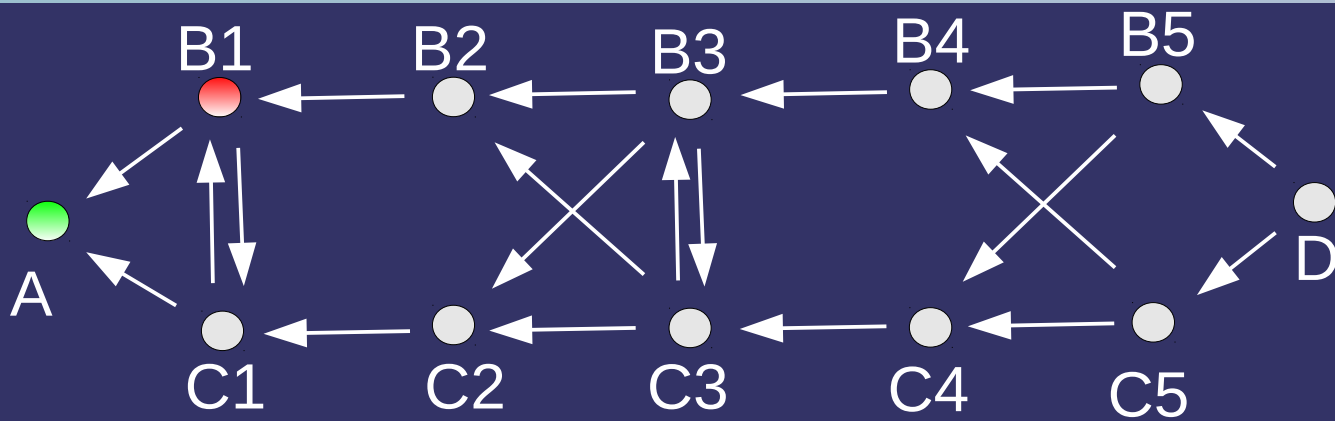

P: HTB(A)

O: CB(B1)

Example

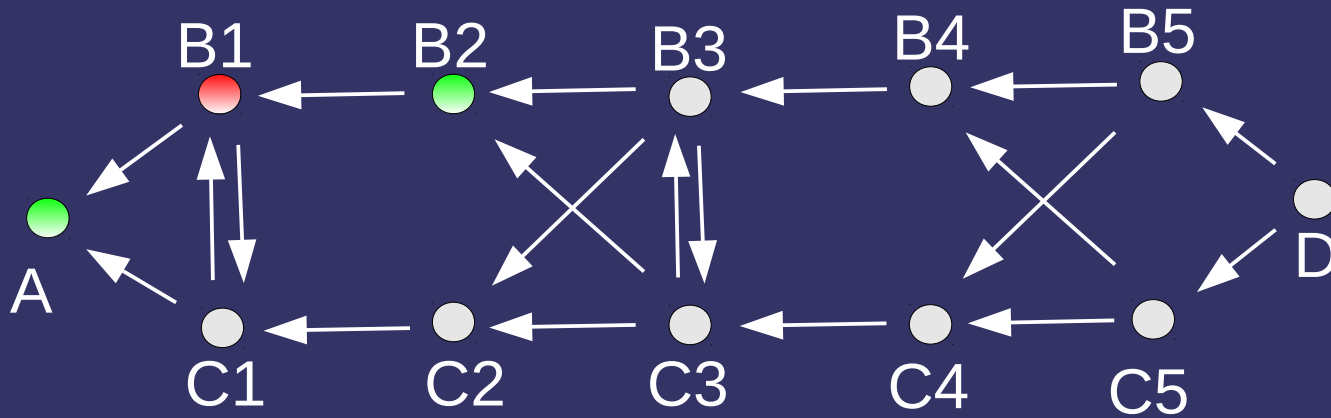

P: HTB(A)
O: CB(B1)
P: HTB(B2)

Example

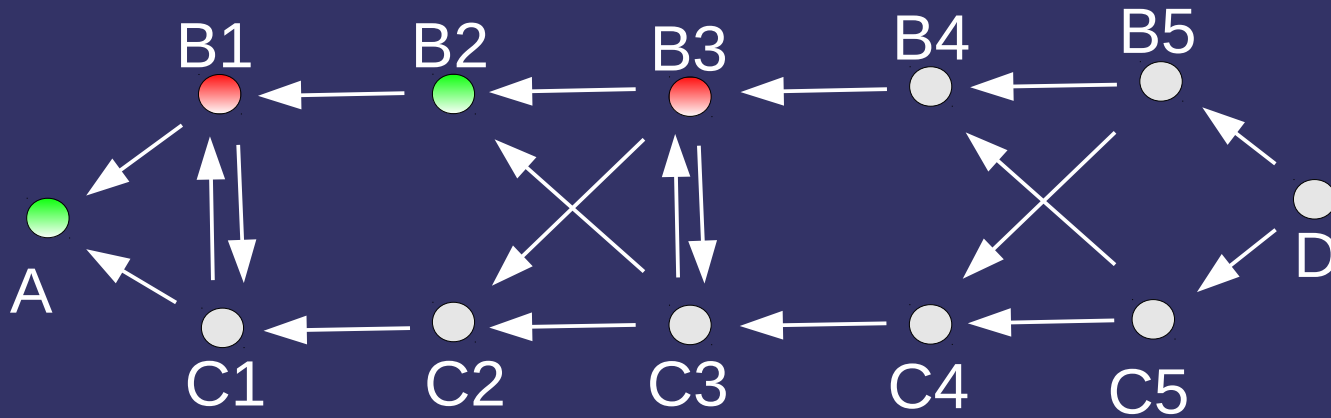

P: HTB(A)
O: CB(B1)
P: HTB(B2)
O: CB(B3)

Example

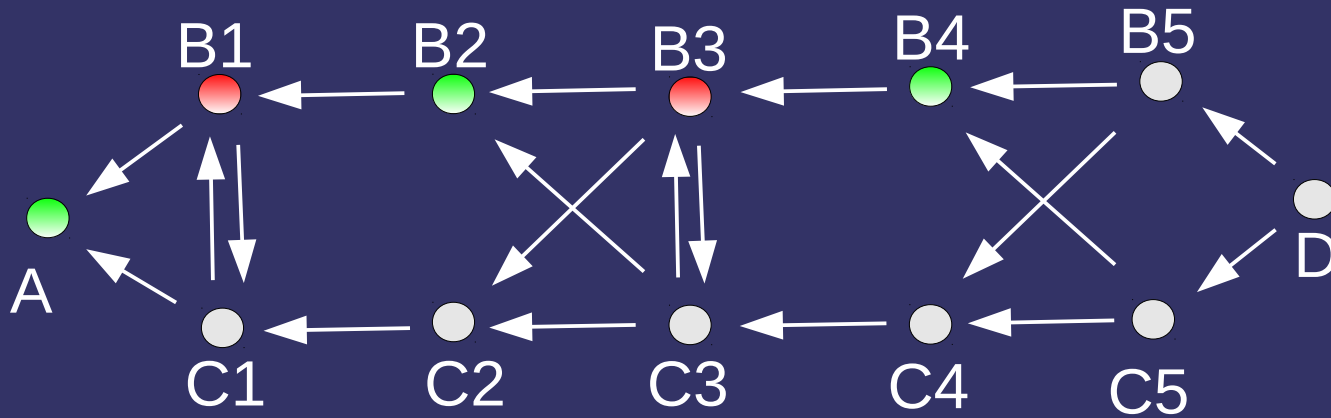

P: HTB(A)
O: CB(B1)
P: HTB(B2)
O: CB(B3)
P: HTB(B4)

Example

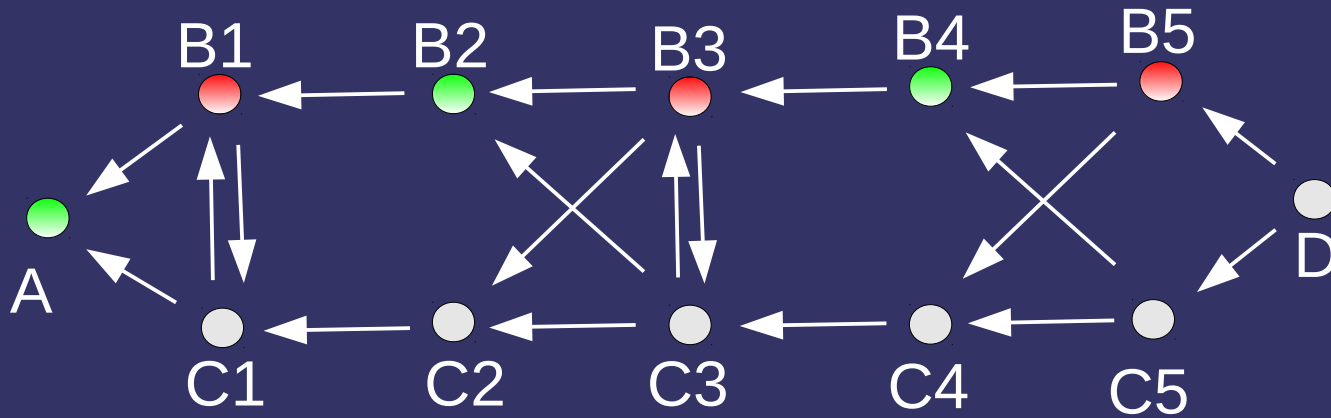

P: HTB(A)
O: CB(B1)
P: HTB(B2)
O: CB(B3)
P: HTB(B4)
O: CB(B5)

Example

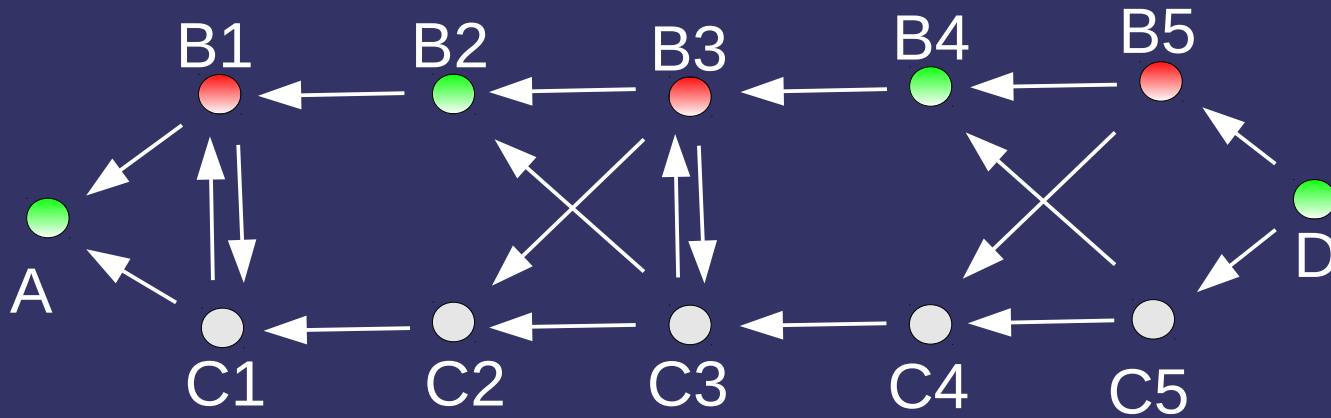

P: HTB(A)
O: CB(B1)
P: HTB(B2)
O: CB(B3)
P: HTB(B4)
O: CB(B5)
P: HTB(D)

Example

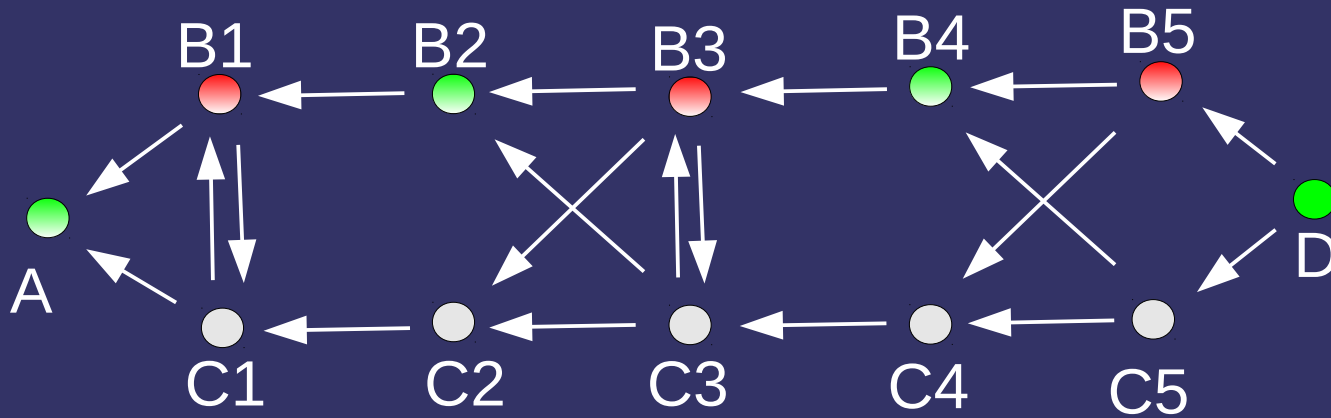

P: HTB(A)
O: CB(B1)
P: HTB(B2)
O: CB(B3)
P: HTB(B4)
O: CB(B5)
P: HTB(D)
O: CONCEDE(D)

Example

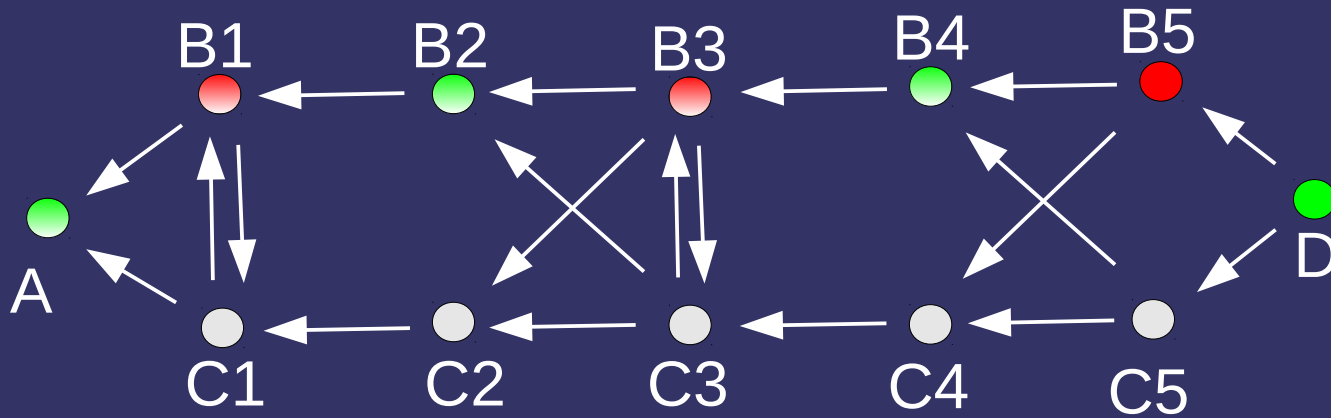

P: HTB(A)
O: CB(B1)
P: HTB(B2)
O: CB(B3)
P: HTB(B4)
O: CB(B5)
P: HTB(D)
O: CONCEDE(D)

O: RETRACT(B5)

Example

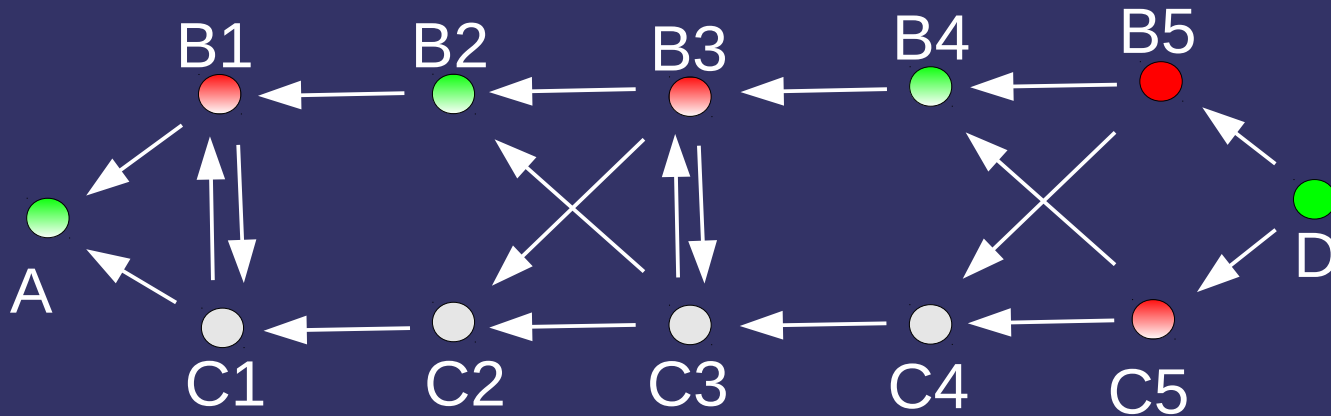

P: HTB(A)
O: CB(B1)
P: HTB(B2)
O: CB(B3)
P: HTB(B4)
O: CB(B5)
P: HTB(D)
O: CONCEDE(D)

O: RETRACT(B5)
O: CB(C5)

Example

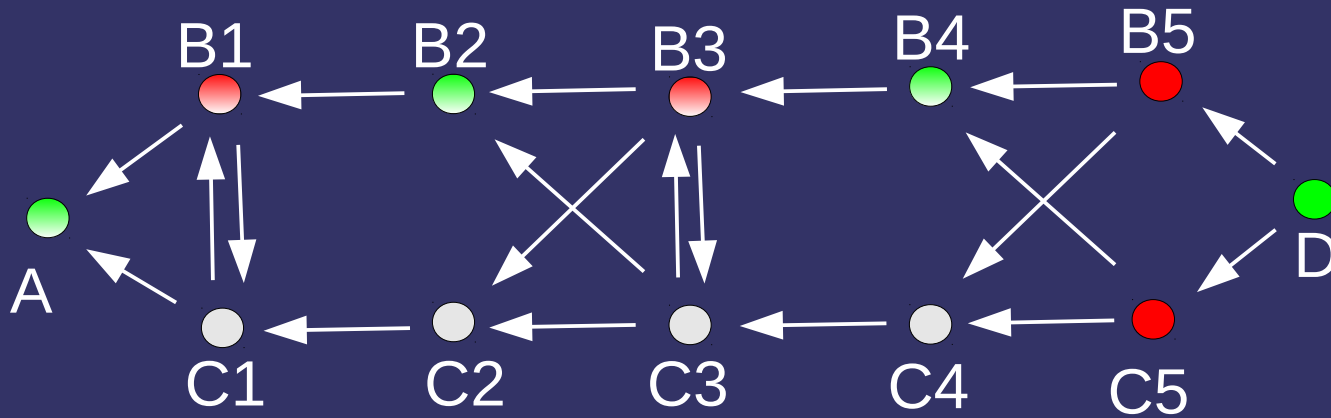

P: HTB(A)
O: CB(B1)
P: HTB(B2)
O: CB(B3)
P: HTB(B4)
O: CB(B5)
P: HTB(D)
O: CONCEDE(D)

O: RETRACT(B5)
O: CB(C5)
O: RETRACT(C5)

Example

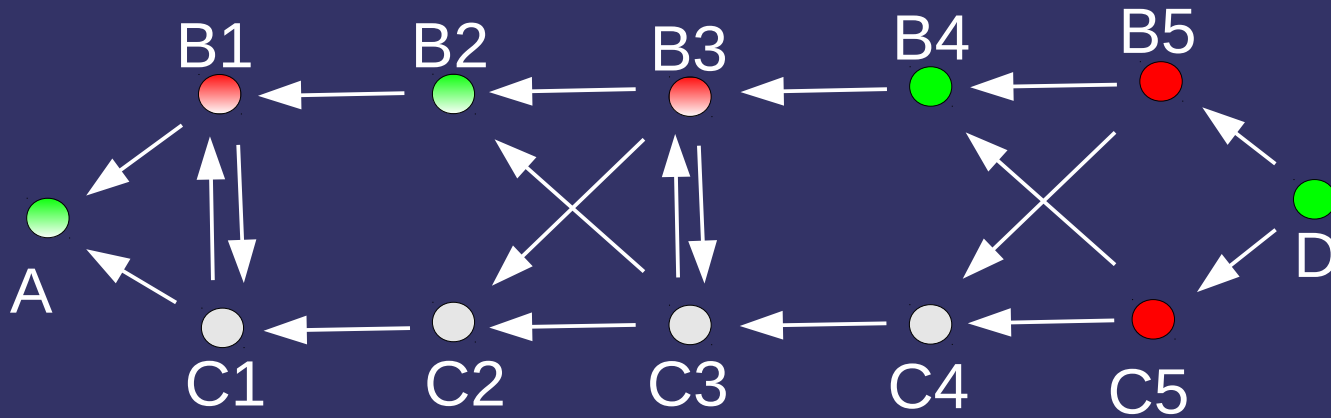

P: HTB(A)
O: CB(B1)
P: HTB(B2)
O: CB(B3)
P: HTB(B4)
O: CB(B5)
P: HTB(D)
O: CONCEDE(D)

O: RETRACT(B5)
O: CB(C5)
O: RETRACT(C5)
O: CONCEDE(B4)

Example

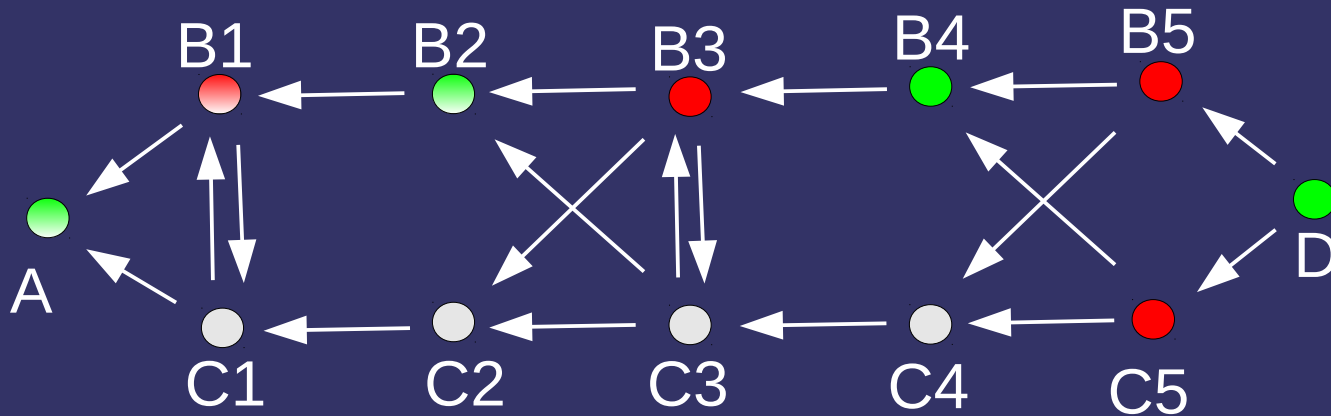

P: HTB(A)
O: CB(B1)
P: HTB(B2)
O: CB(B3)
P: HTB(B4)
O: CB(B5)
P: HTB(D)
O: CONCEDE(D)

O: RETRACT(B5)
O: CB(C5)
O: RETRACT(C5)
O: CONCEDE(B4)
O: RETRACT(B3)

Example

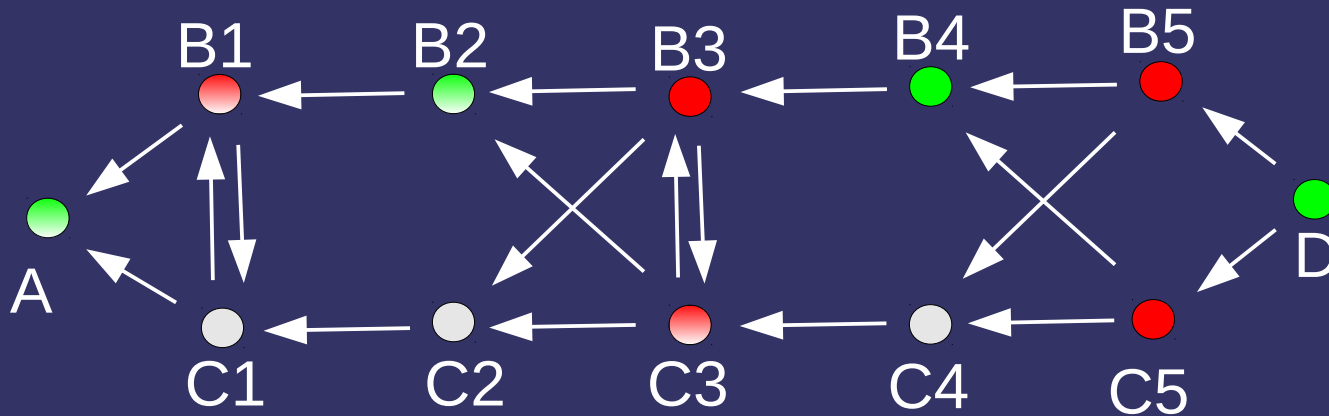

P: HTB(A)
O: CB(B1)
P: HTB(B2)
O: CB(B3)
P: HTB(B4)
O: CB(B5)
P: HTB(D)
O: CONCEDE(D)

O: RETRACT(B5)
O: CB(C5)
O: RETRACT(C5)
O: CONCEDE(B4)
O: RETRACT(B3)
O: CB(C3)

Example

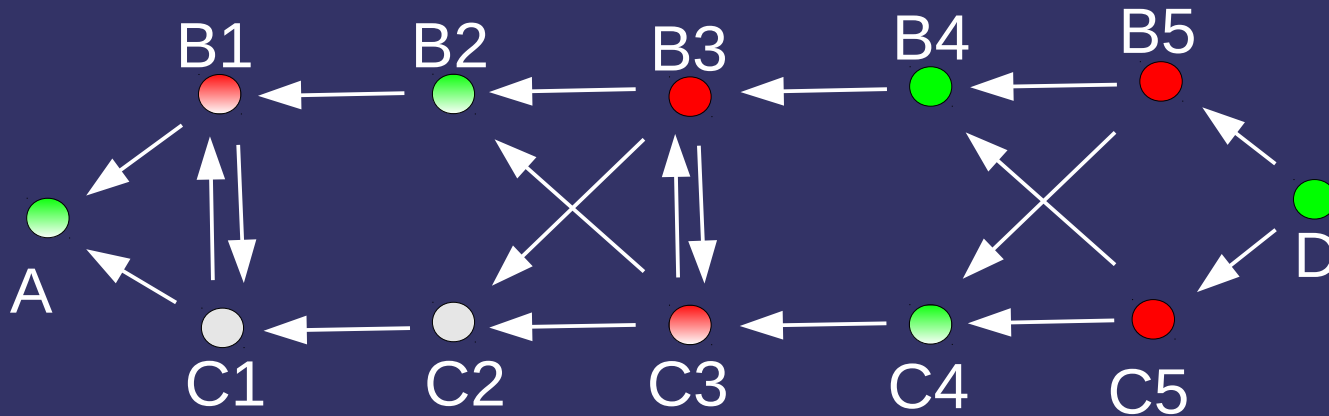

P: HTB(A)
O: CB(B1)
P: HTB(B2)
O: CB(B3)
P: HTB(B4)
O: CB(B5)
P: HTB(D)
O: CONCEDE(D)

O: RETRACT(B5)
O: CB(C5)
O: RETRACT(C5)
O: CONCEDE(B4)
O: RETRACT(B3)
O: CB(C3)
P: HTB(C4)

Example

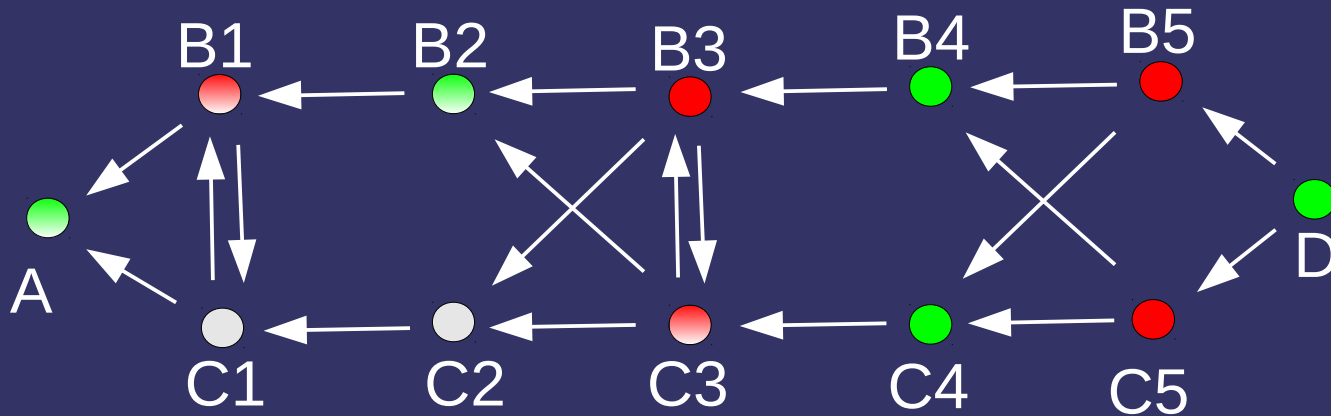

P: HTB(A)
O: CB(B1)
P: HTB(B2)
O: CB(B3)
P: HTB(B4)
O: CB(B5)
P: HTB(D)
O: CONCEDE(D)

O: RETRACT(B5)
O: CB(C5)
O: RETRACT(C5)
O: CONCEDE(B4)
O: RETRACT(B3)
O: CB(C3)
P: HTB(C4)
O: CONCEDE(C4)

Example

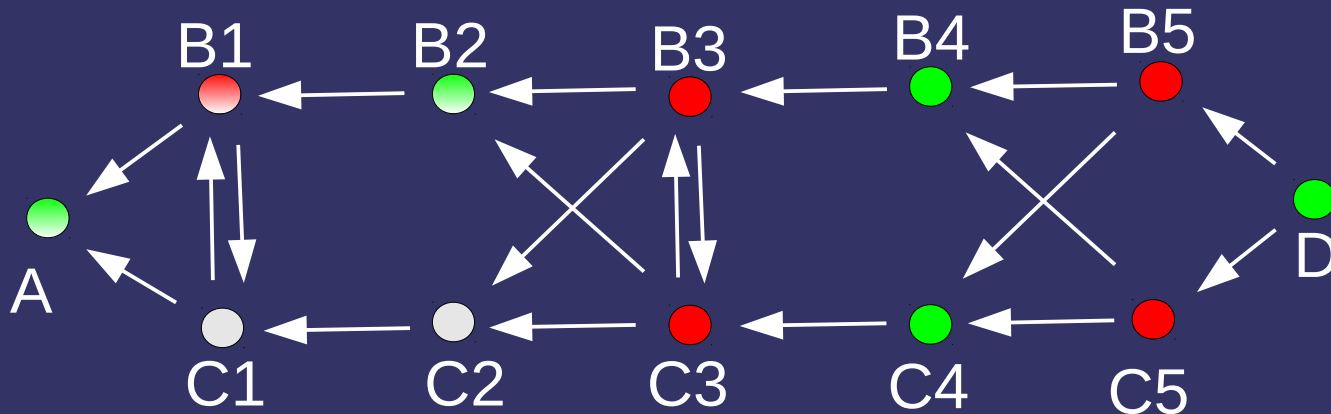

P: HTB(A)
O: CB(B1)
P: HTB(B2)
O: CB(B3)
P: HTB(B4)
O: CB(B5)
P: HTB(D)
O: CONCEDE(D)

O: RETRACT(B5)
O: CB(C5)
O: RETRACT(C5)
O: CONCEDE(B4)
O: RETRACT(B3)
O: CB(C3)
P: HTB(C4)
O: CONCEDE(C4)

O: RETRACT(C3)

Example

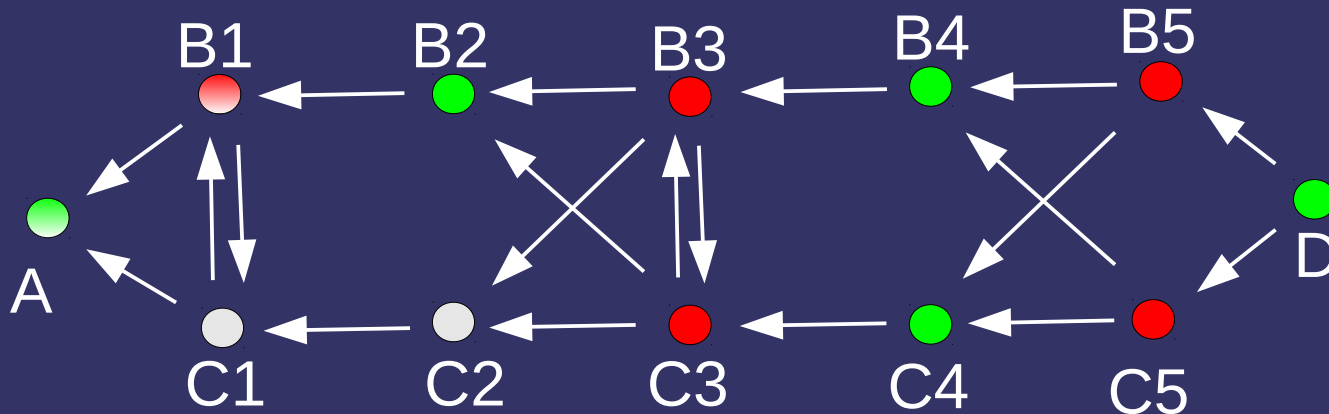

P: HTB(A)
O: CB(B1)
P: HTB(B2)
O: CB(B3)
P: HTB(B4)
O: CB(B5)
P: HTB(D)
O: CONCEDE(D)

O: RETRACT(B5)
O: CB(C5)
O: RETRACT(C5)
O: CONCEDE(B4)
O: RETRACT(B3)
O: CB(C3)
P: HTB(C4)
O: CONCEDE(C4)

O: RETRACT(C3)
O: CONCEDE(B2)

Example

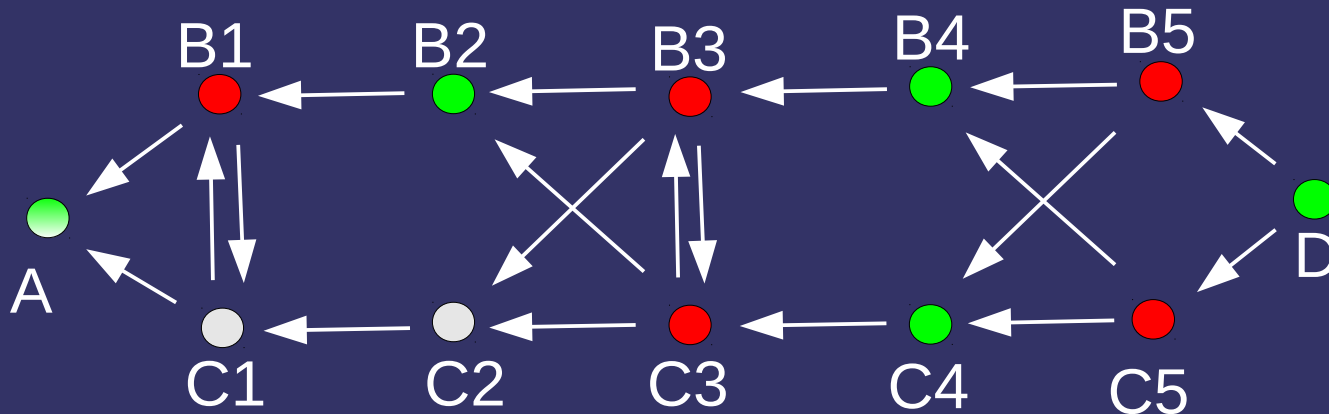

P: HTB(A)
O: CB(B1)
P: HTB(B2)
O: CB(B3)
P: HTB(B4)
O: CB(B5)
P: HTB(D)
O: CONCEDE(D)

O: RETRACT(B5)
O: CB(C5)
O: RETRACT(C5)
O: CONCEDE(B4)
O: RETRACT(B3)
O: CB(C3)
P: HTB(C4)
O: CONCEDE(C4)

O: RETRACT(C3)
O: CONCEDE(B2)
O: RETRACT(B1)

Example

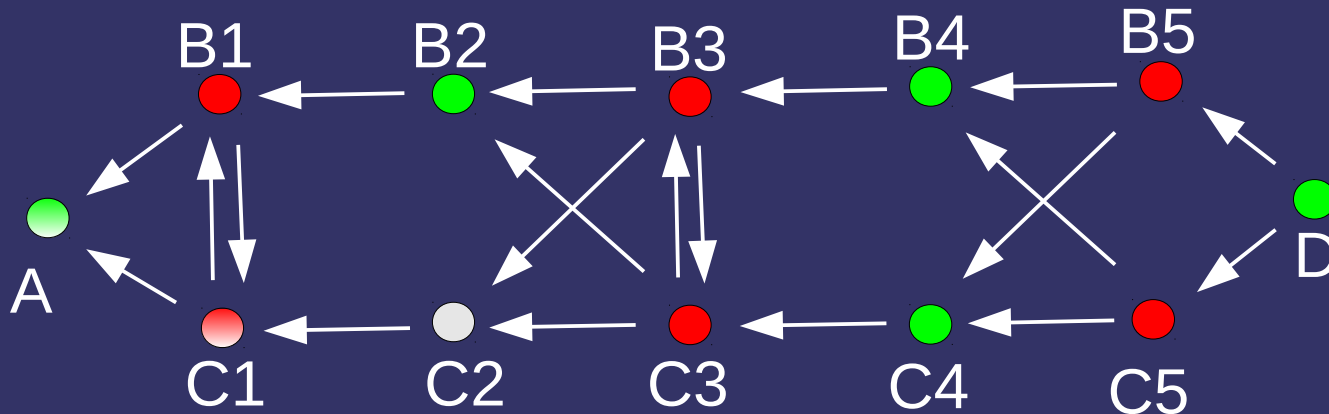

P: HTB(A)
O: CB(B1)
P: HTB(B2)
O: CB(B3)
P: HTB(B4)
O: CB(B5)
P: HTB(D)
O: CONCEDE(D)

O: RETRACT(B5)
O: CB(C5)
O: RETRACT(C5)
O: CONCEDE(B4)
O: RETRACT(B3)
O: CB(C3)
P: HTB(C4)
O: CONCEDE(C4)

O: RETRACT(C3)
O: CONCEDE(B2)
O: RETRACT(B1)
O: CB(C1)

Example

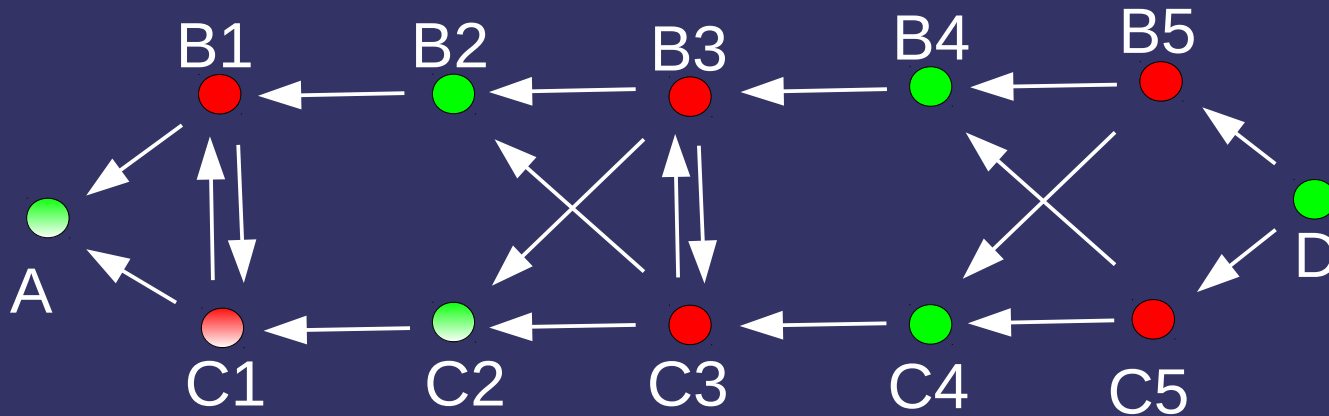

P: HTB(A)
O: CB(B1)
P: HTB(B2)
O: CB(B3)
P: HTB(B4)
O: CB(B5)
P: HTB(D)
O: CONCEDE(D)

O: RETRACT(B5)
O: CB(C5)
O: RETRACT(C5)
O: CONCEDE(B4)
O: RETRACT(B3)
O: CB(C3)
P: HTB(C4)
O: CONCEDE(C4)

O: RETRACT(C3)
O: CONCEDE(B2)
O: RETRACT(B1)
O: CB(C1)
P: HTB(C2)

Example

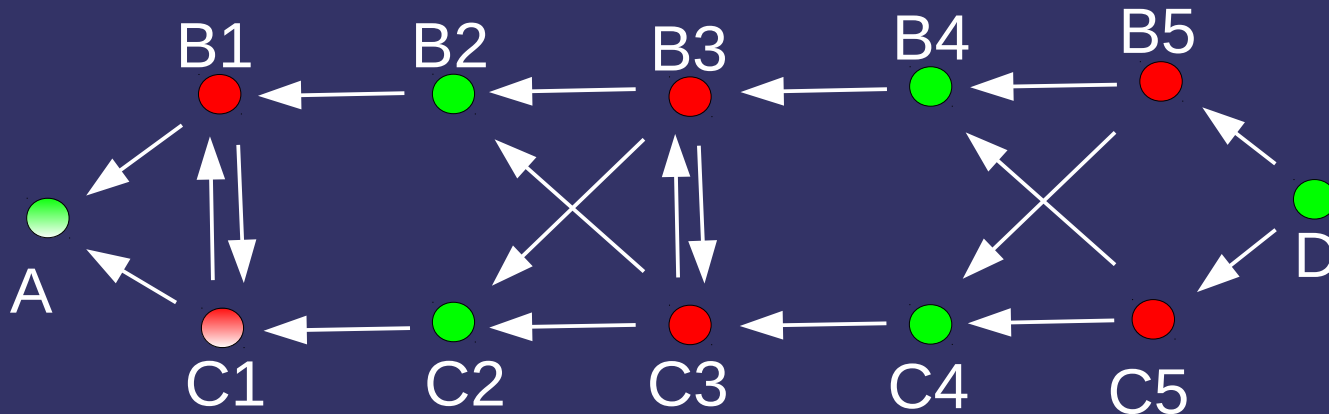

P: HTB(A)
O: CB(B1)
P: HTB(B2)
O: CB(B3)
P: HTB(B4)
O: CB(B5)
P: HTB(D)
O: CONCEDE(D)

O: RETRACT(B5)
O: CB(C5)
O: RETRACT(C5)
O: CONCEDE(B4)
O: RETRACT(B3)
O: CB(C3)
P: HTB(C4)
O: CONCEDE(C4)

O: RETRACT(C3)
O: CONCEDE(B2)
O: RETRACT(B1)
O: CB(C1)
P: HTB(C2)
O: CONCEDE(C2)

Example

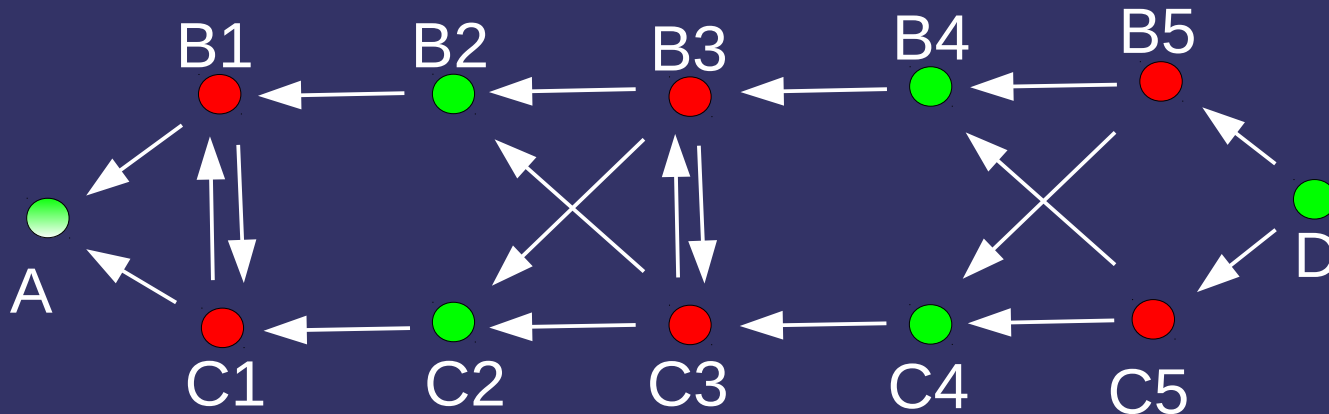

P: HTB(A)
O: CB(B1)
P: HTB(B2)
O: CB(B3)
P: HTB(B4)
O: CB(B5)
P: HTB(D)
O: CONCEDE(D)

O: RETRACT(B5)
O: CB(C5)
O: RETRACT(C5)
O: CONCEDE(B4)
O: RETRACT(B3)
O: CB(C3)
P: HTB(C4)
O: CONCEDE(C4)

O: RETRACT(C3)
O: CONCEDE(B2)
O: RETRACT(B1)
O: CB(C1)
P: HTB(C2)
O: CONCEDE(C2)
O: RETRACT(C1)

Example

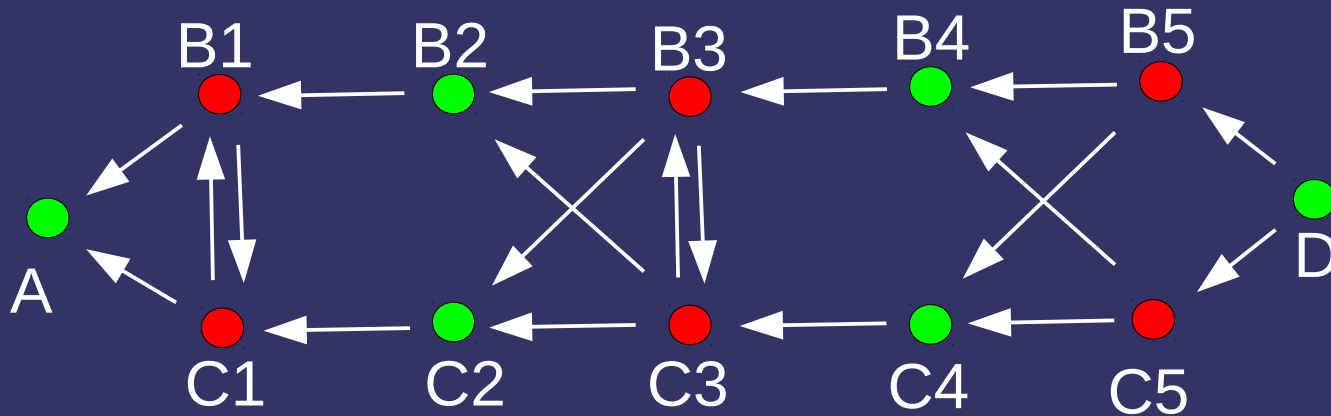

P: HTB(A)
O: CB(B1)
P: HTB(B2)
O: CB(B3)
P: HTB(B4)
O: CB(B5)
P: HTB(D)
O: CONCEDE(D)

O: RETRACT(B5)
O: CB(C5)
O: RETRACT(C5)
O: CONCEDE(B4)
O: RETRACT(B3)
O: CB(C3)
P: HTB(C4)
O: CONCEDE(C4)

O: RETRACT(C3)
O: CONCEDE(B2)
O: RETRACT(B1)
O: CB(C1)
P: HTB(C2)
O: CONCEDE(C2)
O: RETRACT(C1)
O: CONCEDE(A)

Example



Example



P: HTB(D)

Example



P: HTB(D)

O: CB(C)

Example



P: HTB(D)

O: CB(C)

P: HTB(B)

Example



P: HTB(D)

O: CB(C)

P: HTB(B)

O: CB(A)

Example



P: HTB(D)

O: CB(C)

P: HTB(B)

O: CB(A)

*Proponent cannot move anymore, so discussion is terminated.
Main claim not CONCEDEd, so proponent loses.*

Example

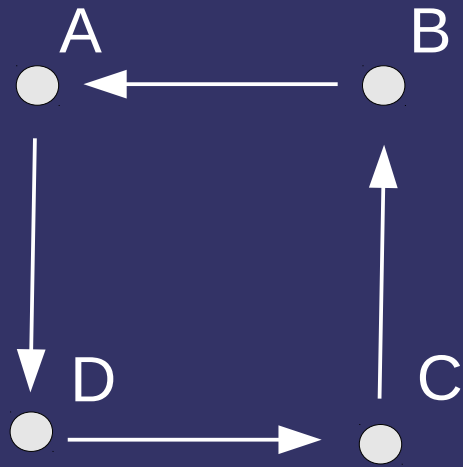

Example

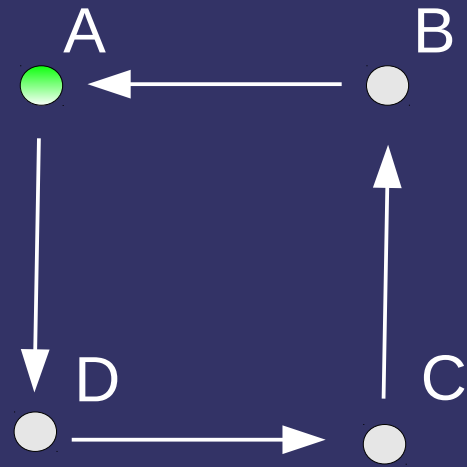

P: HTB(A)

Example

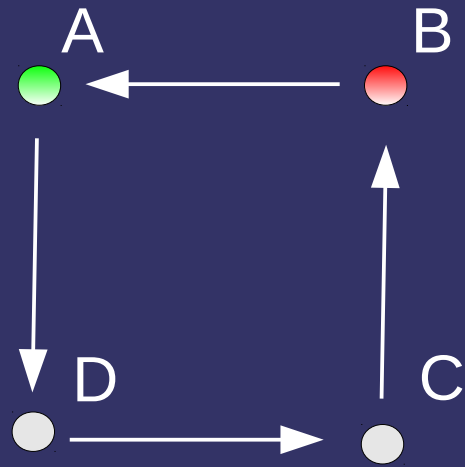

P: HTB(A)

O: CB(B)

Example

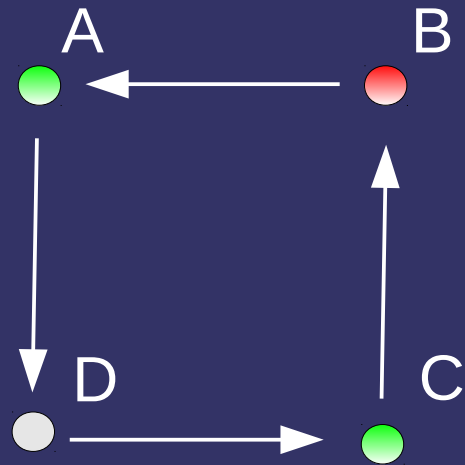

P: HTB(A)

O: CB(B)

P: HTB(C)

Example

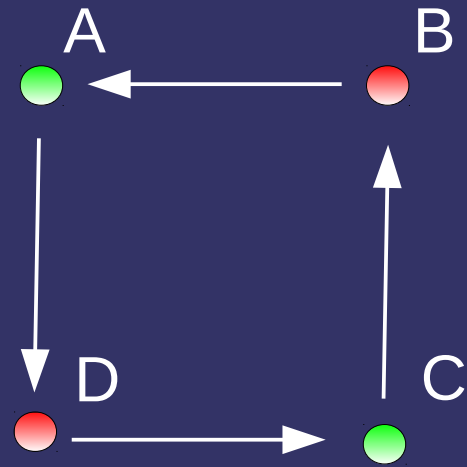

P: HTB(A)

O: CB(B)

P: HTB(C)

O: CB(D)

Example

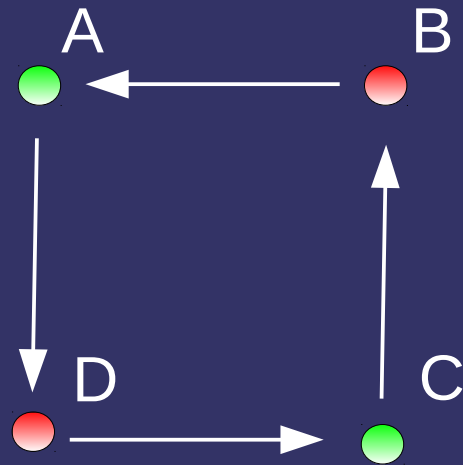

P: HTB(A)

O: CB(B)

P: HTB(C)

O: CB(D)

P: HTB(A)

Example

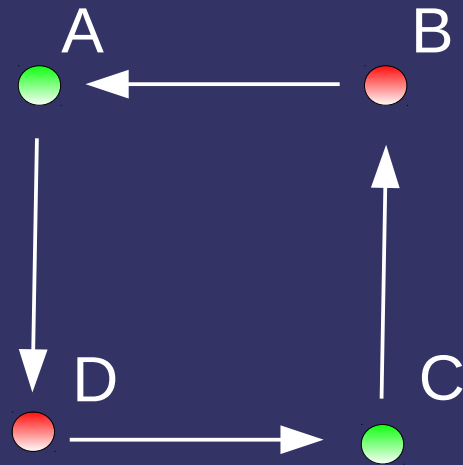

P: HTB(A)
O: CB(B)
P: HTB(C)
O: CB(D)
P: HTB(A)

*Now we have a HTB(A)-HTB(A) repeat,
so all following moves are blocked:
discussion terminated.*

*Main claim not CONCEDEd,
so proponent loses*

***A Discussion Game
for Grounded Semantics (3/3)***

A Discussion Game for Grounded Semantics (3/3)

- A discussion is *terminated* iff no next move is possible

A Discussion Game for Grounded Semantics (3/3)

- A discussion is *terminated* iff no next move is possible
- A terminated discussion (starting with HTB(A)) is won by the proponent iff the opponent has moved CONCEDE(A)

A Discussion Game for Grounded Semantics (3/3)

- A discussion is *terminated* iff no next move is possible
- A terminated discussion (starting with HTB(A)) is won by the proponent iff the opponent has moved CONCEDE(A)
- **in**(Lab_o) = all CONCEDEd arguments
- **out**(Lab_o) = all RETRACTed arguments

A Discussion Game for Grounded Semantics (3/3)

- A discussion is *terminated* iff no next move is possible
- A terminated discussion (starting with HTB(A)) is won by the proponent iff the opponent has moved CONCEDE(A)
- $\text{in}(\text{Lab}_o)$ = all CONCEDEd arguments
- $\text{out}(\text{Lab}_o)$ = all RETRACTed arguments
- At any point of the discussion, Lab_o is strongly admissible

A Discussion Game for Grounded Semantics (3/3)

- A discussion is *terminated* iff no next move is possible
- A terminated discussion (starting with HTB(A)) is won by the proponent iff the opponent has moved CONCEDE(A)
- **in**(Lab_o) = all CONCEDEd arguments
out(Lab_o) = all RETRACTed arguments
- At any point of the discussion, Lab_o is strongly admissible
- correctness: if a discussion is won by the proponent, then the main argument is **in** in the grounded labelling

A Discussion Game for Grounded Semantics (3/3)

- A discussion is *terminated* iff no next move is possible
- A terminated discussion (starting with HTB(A)) is won by the proponent iff the opponent has moved CONCEDE(A)
- **in**(Lab_o) = all CONCEDEd arguments
- **out**(Lab_o) = all RETRACTed arguments
- At any point of the discussion, Lab_o is strongly admissible
- correctness: if a discussion is won by the proponent, then the main argument is **in** in the grounded labelling
- completeness: if an argument is **in** in the grounded labelling, then the proponent has a winning strategy for it

A Discussion Game for Grounded Semantics (3/3)

- A discussion is *terminated* iff no next move is possible
- A terminated discussion (starting with HTB(A)) is won by the proponent iff the opponent has moved CONCEDE(A)
- $\text{in}(\text{Lab}_\circ)$ = all CONCEDEd arguments
- $\text{out}(\text{Lab}_\circ)$ = all RETRACTed arguments
- At any point of the discussion, Lab_\circ is strongly admissible
- correctness: if a discussion is won by the proponent, then the main argument is in the grounded extension
- completeness: if an argument is in the grounded extension, then the proponent has a winning strategy for it

Example

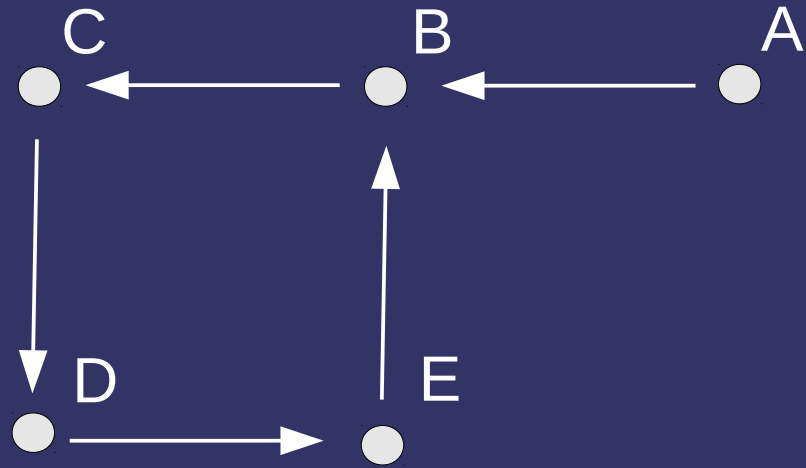

Example

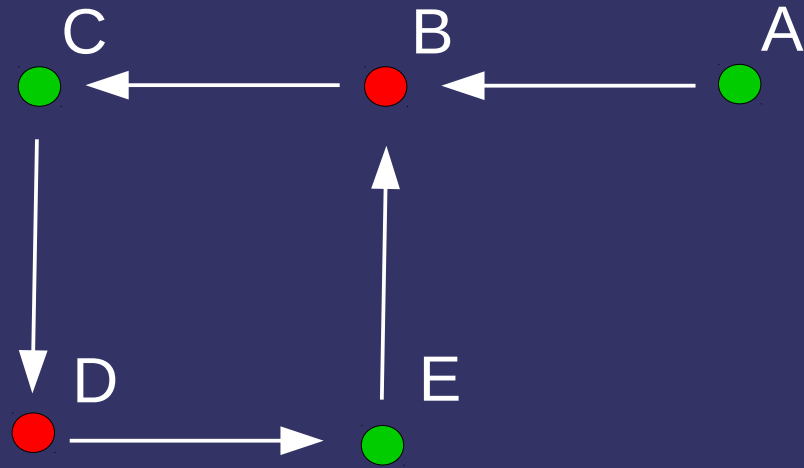

Example

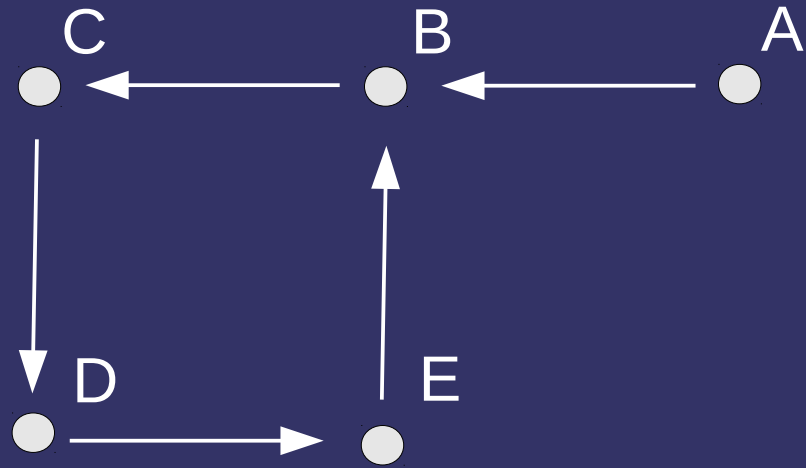

Example

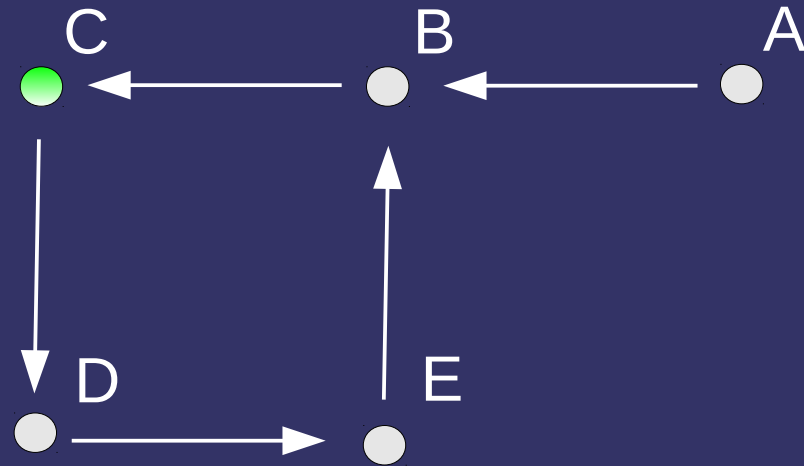

P: HTB(C)

Example

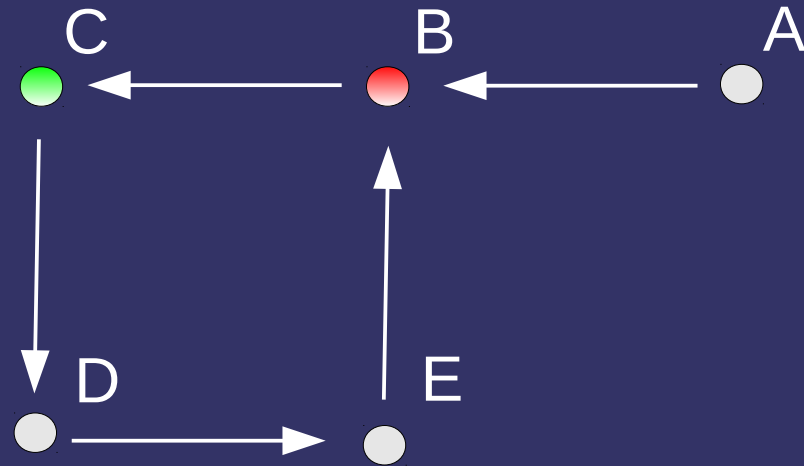

P: HTB(C)

O: CB(B)

Example

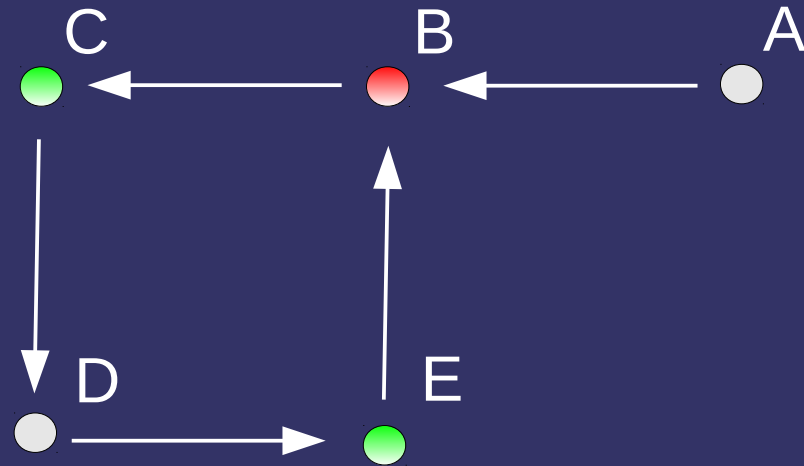

P: HTB(C)

O: CB(B)

P: HTB(E)

Example

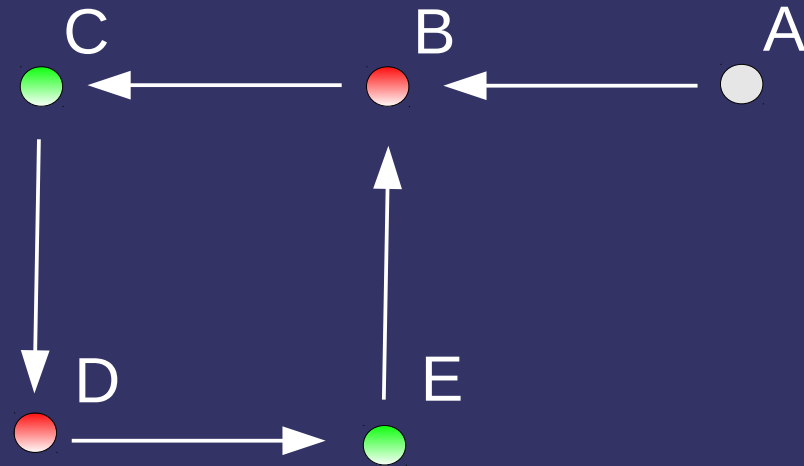

P: HTB(C)

O: CB(B)

P: HTB(E)

O: CB(D)

Example

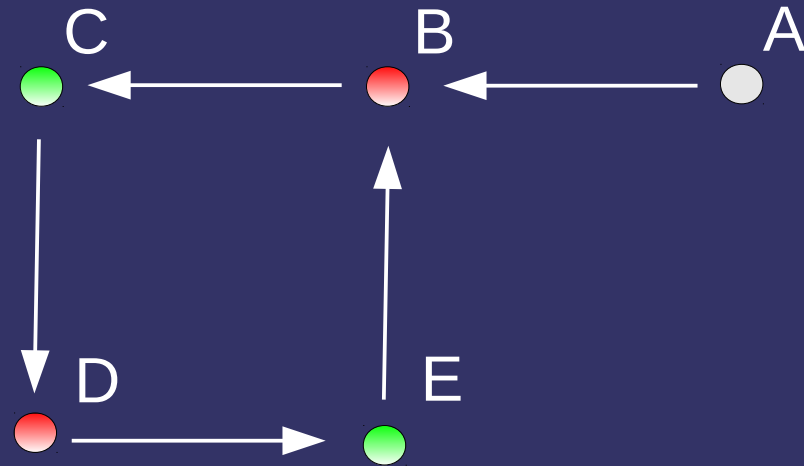

P: HTB(C)

O: CB(B)

P: HTB(E)

O: CB(D)

P: HTB(C)

Example

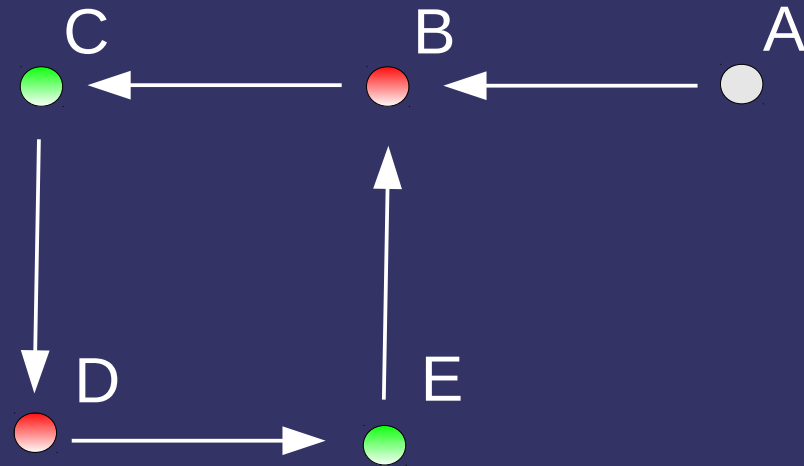

P: HTB(C)

O: CB(B)

P: HTB(E)

O: CB(D)

Example

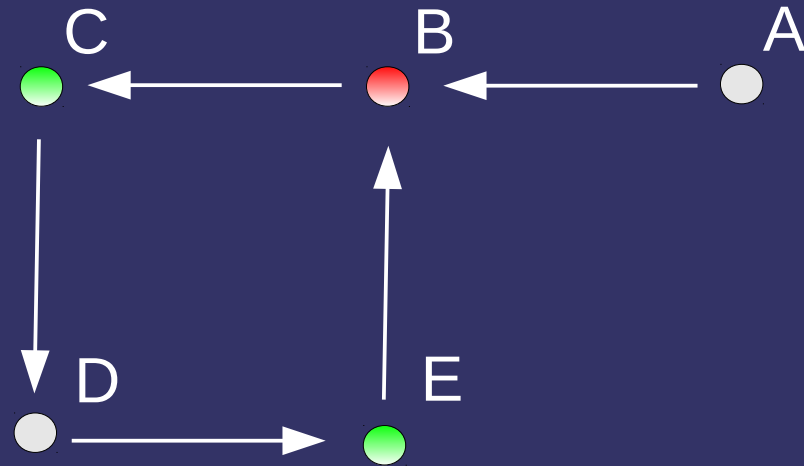

P: HTB(C)

O: CB(B)

P: HTB(E)

Example

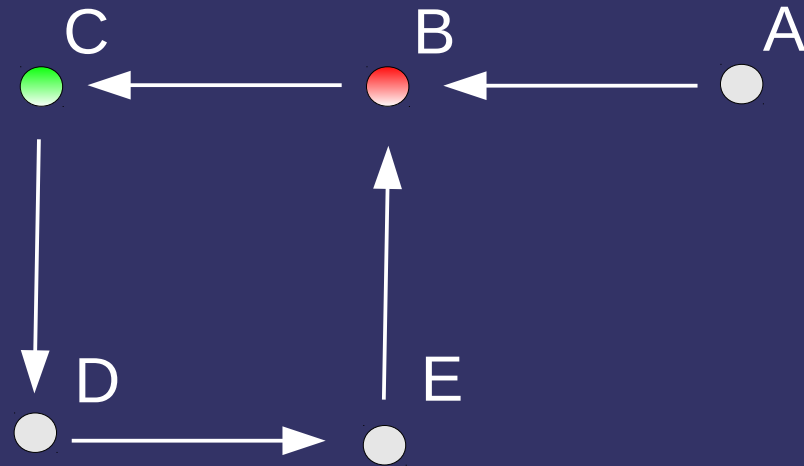

P: HTB(C)

O: CB(B)

Example

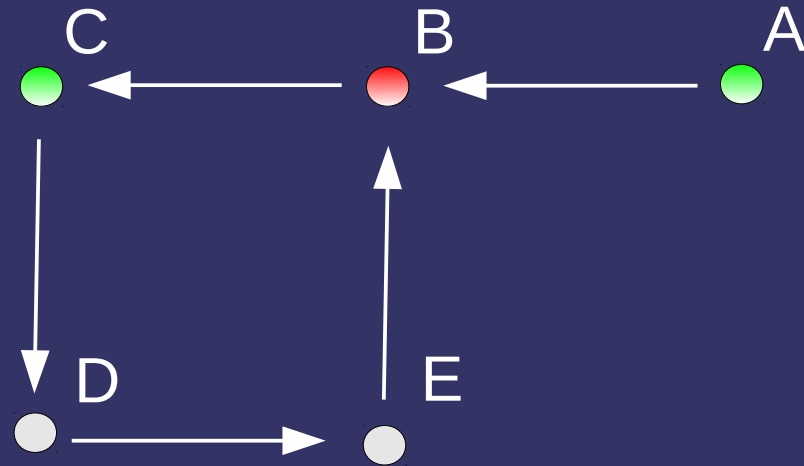

P: HTB(C)

O: CB(B)

P: HTB(A)

Example

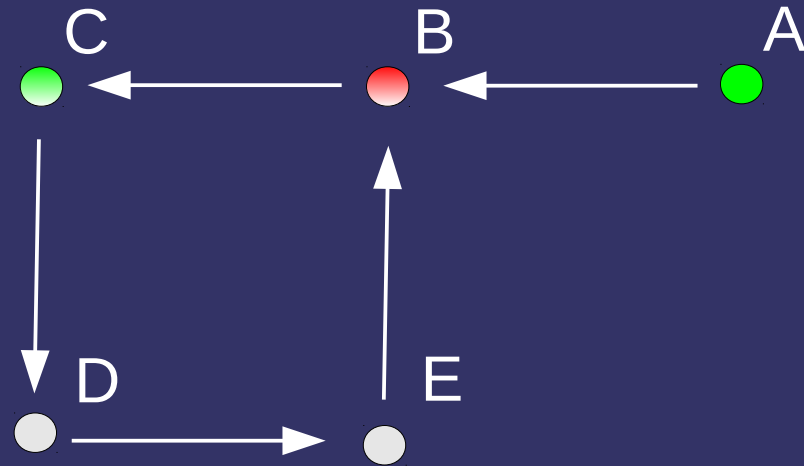

P: HTB(C)

O: CB(B)

P: HTB(A)

O: CONCEDE(A)

Example

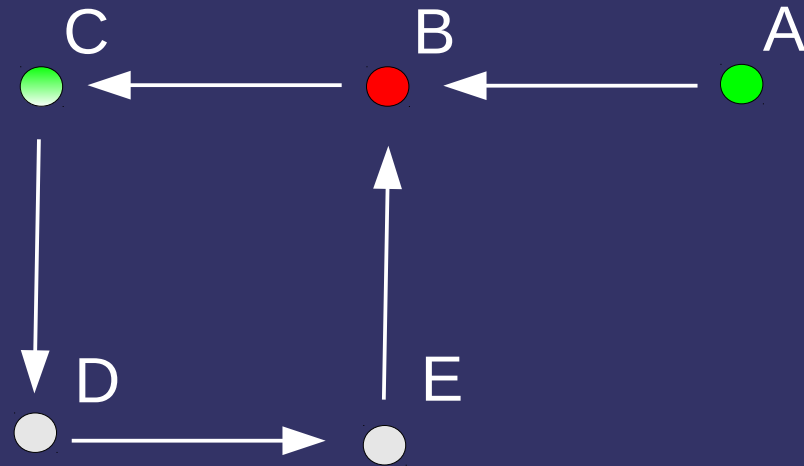

P: HTB(C)

O: CB(B)

P: HTB(A)

O: CONCEDE(A)

O: RETRACT(B)

Example

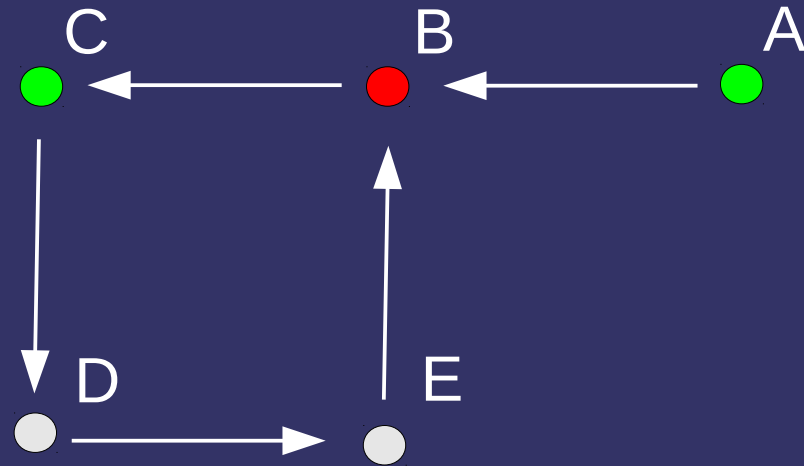

P: HTB(C)

O: CB(B)

P: HTB(A)

O: CONCEDE(A)

O: RETRACT(B)

O: CONCEDE(C)

Example

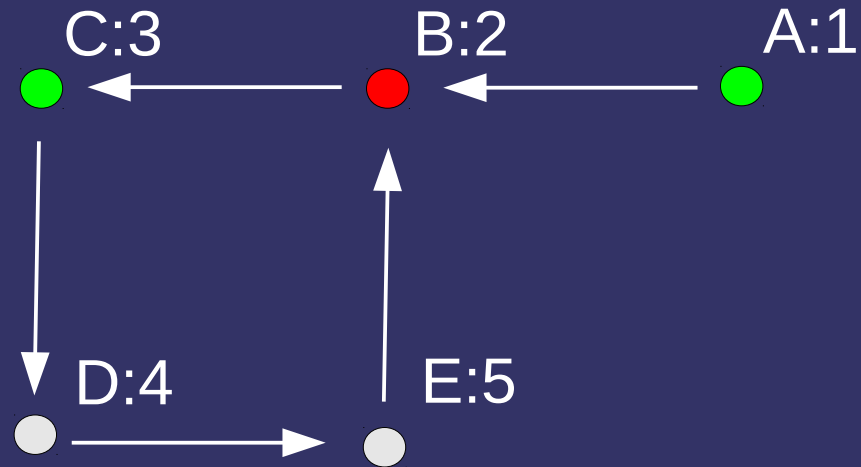

P: HTB(C)

O: CB(B)

P: HTB(A)

O: CONCEDE(A)

O: RETRACT(B)

O: CONCEDE(C)

Example [Prakken]

Example [Prakken]

Paul: My car is very safe, because it has an airbag.

Olga: I do not think having an airbag makes your car safe, because airbags are unreliable: the newspapers had several reports on cases where airbags did not work.

Paul: A recent scientific study shows that airbags are in fact 99% reliable, and scientific studies are more important than newspaper reports.

Olga: OK, I admit that airbags are reliable. However, your car is not very safe, since its maximum speed is much too high.

Example [Prakken]

- P: My car is very safe, because it has an airbag.
- O: I do not think having an airbag makes your car safe, because airbags are unreliable: the newspapers had several reports on cases where airbags did not work.
- P: A recent scientific study shows that airbags are in fact 99% reliable, and scientific studies are more important than newspaper reports.
- O: OK, I admit that airbags are reliable. However, your car is not very safe, since its maximum speed is much too high.

Example [Prakken]

P: HTB(airbag \Rightarrow safe)

O: I do not think having an airbag makes your car safe, because airbags are unreliable: the newspapers had several reports on cases where airbags did not work.

P: A recent scientific study shows that airbags are in fact 99% reliable, and scientific studies are more important than newspaper reports.

O: OK, I admit that airbags are reliable. However, your car is not very safe, since its maximum speed is much too high.

Example [Prakken]

P: HTB(airbag \Rightarrow safe)

O: CB(npr $\Rightarrow \neg$ airbagrel $\Rightarrow \neg$ [airbag \Rightarrow safe])

P: A recent scientific study shows that airbags are in fact 99% reliable, and scientific studies are more important than newspaper reports.

O: OK, I admit that airbags are reliable.
However, your car is not very safe,
since its maximum speed is much too high.

Example [Prakken]

P: HTB(airbag \Rightarrow safe)

O: CB(npr $\Rightarrow \neg$ airbagrel $\Rightarrow \neg$ [airbag \Rightarrow safe])

P: HTB(study \Rightarrow airbagrel)

O: OK, I admit that airbags are reliable.
However, your car is not very safe,
since its maximum speed is much too high.

Example [Prakken]

P: HTB(airbag \Rightarrow safe)

O: CB(npr $\Rightarrow \neg$ airbagrel $\Rightarrow \neg$ [airbag \Rightarrow safe])

P: HTB(study \Rightarrow airbagrel)

O: CONCEDE(study \Rightarrow airbagrel)

However, your car is not very safe,
since its maximum speed is much too high.

Example [Prakken]

P: HTB(airbag \Rightarrow safe)

O: CB(npr \Rightarrow \neg airbagrel \Rightarrow \neg [airbag \Rightarrow safe])

P: HTB(study \Rightarrow airbagrel)

O: CONCEDE(study \Rightarrow airbagrel)

RETRACT(npr \Rightarrow \neg airbagrel \Rightarrow \neg [airbag \Rightarrow safe])

Example [Prakken]

P: HTB(airbag \Rightarrow safe)

O: CB(npr \Rightarrow \neg airbagrel \Rightarrow \neg [airbag \Rightarrow safe])

P: HTB(study \Rightarrow airbagrel)

O: CONCEDE(study \Rightarrow airbagrel)

RETRACT(npr \Rightarrow \neg airbagrel \Rightarrow \neg [airbag \Rightarrow safe])

CB(highspeed \Rightarrow \neg safe)

Previous Discussion Games

	Standard Grounded Game	Grounded Persuasion Game	Grounded Discussion Game
#moves needed to show str. adm.	exponential	linear	linear
RETRACT/ CONCEDE moves	no	yes	yes
single successful game is sufficient	no	yes	yes
in grounded implies \exists winning strategy	yes	no	yes